



Transmittal Number PT 13-030	Date April 2013
Publication Distribution To: <i>Utilities Manual</i> holders	
Publication Title <i>Utilities Manual</i> – April 2013	Publication Number M 22-87.05
Originating Organization HQ Development Division, Design Office – Utilities, Railroads, and Agreements Section	

Remarks and Instructions

What’s changed in the Utilities Manual for April 2013?

Chapter 1 – Utility Accommodation

- “Assignment of Escrow” has been replaced with “Escrow Agreement.”

Chapter 2 – Utility Agreements

- Dates were corrected to bring them in line with Chapter 4 of the *Accounting Manual*.

Chapter 9 – Control Zone Guidelines

- Chapter 9 has been reorganized for clarity and flow, and to bring consistency to terms in identifying typical conditions where that information was drawn from the *Design Manual*.

Appendix B – Utility Forms and Documents

- “Utility Installations to Existing Bridges” has been added.
- “Utility Construction Agreement Work by Utility – State Cost” has been modified.
- “Assignment of Escrow Account” form has been replaced with “Escrow Agreement Utilities.”
- “Control Zone Location I and II Variance Request Justification Questionnaire” has been replaced with “Control Zone Variance Request” to be consistent with the updated Chapter 9.
- The “Authority Matrix” has been updated to specify “Full” Limited where needed.
- The missing General Provisions from “Application for Utility Permit or Franchise” have been added.
- “Engineering” has been added to the “Utility Preliminary Engineering Agreement Work by State – Utility Cost.”
- The “Environmental Impact Checklist” has been removed; it is no longer used.

HQ Design Office Signature

/s/ Ahmer Nizam

Remove/Insert instructions for those who maintain a printed manual:

CHAPTER	REMOVE PAGES	INSERT PAGES
Contents	v – vii	v – vii
Chapter 1 Utility Accommodation	1-31 – 1-34	1-31 – 1-34
Chapter 2 Control Zone Guidelines	2-19 – 2-20	2-19 – 2-20
Chapter 9 Control Zone Guidelines	9-1 – 9-26	9-1 – 9-22
Appendix B Utility Forms and Documents	B-1 – B-118	B-1 – B-126

Revision marks

- A new date appears on the footer of each page that has changes.
- Revision marks (underlines/sidebars) are used as a convenience to show what has changed.
- When a chapter is completely rewritten, no revision marks are applied.

Need more information?

Contact the WSDOT HQ Utilities, Railroads, and Agreements Section – Utilities Unit:

 www.wsdot.wa.gov/utilities/

To get the latest information on individual publications, please sign up for e-mail updates:

 www.wsdot.wa.gov/publications/manuals/



**Washington State
Department of Transportation**

Utilities Manual

M 22-87.05

April 2013

Engineering and Regional Operations
Development Division, Design Office

Americans with Disabilities Act (ADA) Information

Materials can be provided in alternative formats by calling the ADA Compliance Manager at 360-705-7097. Persons who are deaf or hard of hearing may contact that number via the Washington Relay Service at 7-1-1.

Title VI Notice to the Public

It is Washington State Department of Transportation (WSDOT) policy to ensure no person shall, on the grounds of race, color, national origin, or sex, as provided by Title VI of the Civil Rights Act of 1964, be excluded from participation in, be denied the benefits of, or be otherwise discriminated against under any of its federally funded programs and activities. Any person who believes his/her Title VI protection has been violated may file a complaint with WSDOT's Office of Equal Opportunity (OEO). For Title VI complaint forms and advice, please contact OEO's Title VI Coordinator at 360-705-7082 or 509-324-6018.

To get the latest information on WSDOT publications, sign up for individual email updates at www.wsdot.wa.gov/publications/manuals.

Washington State Department of Transportation
Development Division, Design Office
PO Box 47329
Olympia, WA 98504-7329
www.wsdot.wa.gov/utilities

Chapter 1	Utility Accommodation	1-1
100	Administration and General Information	1-1
100.01	Utility Accommodation Program Purpose	1-1
100.02	Types of Utility Accommodation Documents	1-2
100.03	Installation Categories	1-5
100.04	Utility Classification Criteria	1-11
100.05	Accommodation Documents: Management and Administration	1-13
100.06	Approval Authority	1-14
100.07	Accommodation Process and Procedure	1-16
110	General Requirements	1-21
110.01	Accommodation Application Requirements	1-21
110.02	Franchise Consolidation and Franchise Renewal Process and Requirements	1-23
110.03	Fees and Reimbursable Accounts	1-29
110.04	Sureties	1-31
110.05	Local, State, or Federal Agencies	1-35
120	Specific Installation Requirements	1-37
120.01	Hearings	1-37
120.02	City Streets as Part of State Highways	1-37
120.03	Annexations and Route Jurisdiction Transfers	1-38
120.04	Pipelines	1-40
120.05	Storm Drainage and Hydraulics	1-50
120.06	Open Cuts and Trenching	1-53
120.07	Bridges and Structures	1-58
120.08	Scenic Classification Policy	1-68
120.09	Control Zone	1-71
120.10	Joint-Use and Future-Use Utilities	1-72
120.11	Access Control	1-73
120.12	Environmental Considerations	1-74
120.13	Utility Maintenance	1-76
120.14	Variances: Types, Treatment, and Approval	1-77
120.15	Casing, Conduit, Innerduct, and Encasement	1-82
130	Post-Approval Administration	1-85
130.01	Addenda to Approved Accommodation Documents	1-85
130.02	Extension of Installation Time	1-89
130.03	As-Builts: Record Drawings	1-90
130.04	Penalties	1-90
130.05	Utility Transfer of Ownership – Acceptance of Assignment	1-91
130.06	Abandoned, Deactivated, or Disconnected Utilities	1-93
130.07	Undocumented Utility Installations	1-95
130.08	Turnback Areas and Construction Permits	1-97
130.09	Compliance Reviews	1-99

Chapter 2	Utility Agreements	2-1
	200.01 General	2-1
	200.02 Utility Property Rights	2-3
	200.03 Preliminary Engineering Agreements	2-6
	200.04 Construction Agreements	2-14
Chapter 3	Railroads	3-1
	300.01 General	3-1
	300.02 Responsibilities	3-1
	300.03 Railroad Requirements	3-2
	300.04 Railroad Crossings	3-4
Chapter 4	Service Agreements	4-1
	400.01 General	4-1
	400.02 Agreement Number	4-2
	400.03 Agreement Authorization	4-2
	400.04 Distribution of Agreement	4-2
Chapter 5	Government Agencies: State, Federal, Tribal, and Other Entities ..	5-1
	500.01 General	5-1
	500.02 State Agencies	5-1
	500.03 Federal Agencies	5-2
	500.04 Tribal Authorities	5-8
	500.05 Railroad Companies	5-9
Chapter 6	Project Delivery and Utility Relocation	6-1
	600.01 General	6-1
	600.02 Schedules, Goals, and Strategies	6-1
	600.03 Early Utility Identification	6-3
	600.04 Coordination, Cooperation, and Communication	6-3
	600.05 Roles and Responsibilities	6-5
	600.06 Cost Responsibility and Recovery	6-6
	600.07 Coordination Milestones	6-8
	600.08 Project Initiation: Project Design Notification	6-8
	600.09 Geometric Review (30%)	6-8
	600.10 Subsurface Utility Engineering (SUE)	6-14
	600.11 Preliminary Engineering Agreements	6-22
	600.12 General Plans Review (60%)	6-22
	600.13 Preliminary Contract Review (90%)	6-26
	600.14 Preadvertisement	6-27
	600.15 Design/Construction Utility Relocation Facilitation	6-27
	600.16 Project Award and Construction	6-28
	600.17 Developer Projects and Utility Relocation	6-29

Chapter 7	Inspection	7-1
	700.01 General	7-1
	700.02 Jurisdiction and Authority	7-2
	700.03 Traffic Control and Safety	7-4
	700.04 Buried Facilities	7-6
	700.05 Aboveground Facilities	7-7
	700.06 Bridge Attachments	7-7
	700.07 Environmental Requirements	7-8
	700.08 Communication With Others	7-9
	700.09 Documentation	7-11
Chapter 8	Reimbursement	8-1
	800.01 General	8-1
	800.02 Utility Accommodation Reimbursement Policy	8-1
Chapter 9	Control Zone Guidelines	9-1
	900.01 General	9-1
	900.02 Clear Zone vs. Control Zone	9-1
	900.03 Control Zone Objectives	9-2
	900.04 Definitions	9-2
	900.05 Application	9-2
	900.06 Control Zone Distance	9-3
	900.07 Recovery Area	9-12
	900.08 Supplemental Utility Design Information	9-13
	900.09 Project Applications	9-15
	900.10 Completing the Utility Object Relocation Record	9-17
	900.11 Variance	9-18
	900.12 Variance Request for Location I Objects	9-19
	900.13 Reclassification Request for Location II Objects	9-19
	900.14 The 5/15 Rule for Location II Objects	9-22
 Appendices		
	Appendix A Glossary	A-1
	Appendix B Utility Forms and Documents	B-1
	Appendix C Policy Guidance	C-1
	Appendix D RCW and WAC References	D-1

(5) Accountability

It is WSDOT's policy that signature by the utility on the Application for Utility Permit or Franchise authorizes the department to charge for all costs associated with processing the utility's application. Language on the application states that the customer agrees to this policy by signature.

When WSDOT experiences difficulties recovering costs from a utility, the utility may be subject to more stringent recovery policies. Consult with region accounting personnel or the State Utilities Engineer if cost recovery becomes an issue with a particular utility.

110.04 Sureties

Sureties provide WSDOT with a means of recovering costs in the event the utility does not meet its obligations with the department. Sureties are required for all utility installations to offset the cost of repair to the highway operating right of way caused by faulty, unsafe, negligent, or other impacts caused by a utility installation. All sureties must indemnify WSDOT as to contractual liability and must provide the department with a means of recovering costs in the event the utility does not meet its obligations to WSDOT.

WAC 468-34-020(3)

(1) Surety Classes

There are two Surety Classes used in conjunction with utility installations within the highway operating right of way.

- (a) **Individual Surety** – An individual surety is a one-time surety attached to a single utility installation project. The surety is released upon satisfactory completion of that utility installation. For additional guidance, see [Surety Release](#) (below).
- (b) **Blanket Surety** – A blanket surety is acceptable for multiple utility installations by a single utility owner and is valid throughout the state of Washington as long as the surety remains in effect. Depending upon the circumstances of a specific utility installation project, a blanket surety may be supplemented by an individual surety if deemed necessary by WSDOT.

(2) Types of Sureties

There are three types of sureties that can be used within each Surety Class. Utilities have the option to choose which surety to use, provided they are eligible to use the surety type.

(a) Individual Surety

1. **Individual Bond** – An Individual Class surety obtained from a licensed bonding agent. Use DOT Form 224-048, Individual Bond for Franchise or Permit (see [Appendix B](#)).
2. **Individual Escrow Agreement (see Appendix B)** – An Individual Class surety obtained from a licensed banking institution, which must be notarized.
3. **Individual Governmental Entity Pool** – An Individual Class surety obtained from an approved entity pool program.

(b) Blanket Surety

1. **Blanket Bond** – A Blanket Class surety obtained from a licensed bonding agent. Use DOT Form 224-012, Blanket Bond for Franchises and Permits (see [Appendix B](#)).
2. **Blanket Escrow Agreement** – A Blanket Class surety obtained from a licensed banking institution, which must be notarized.
3. **Blanket Governmental Entity Pool** – A Blanket Class surety obtained from an approved entity pool program.

WSDOT recognizes that surety bonding may be difficult for some smaller local agencies. Recommend Assignment of Escrow Accounts to smaller agencies with limited resources. Escrow accounts have no cost and they gain interest while held in the bank.

WSDOT should also work closely with local agencies to ensure understanding of surety requirements and how those requirements could affect agency construction schedules. Local agencies should also be made aware of the department's bonding release requirements. If the local agency releases its contractor's bond before WSDOT inspects and releases the local agency's surety with the department, the agency will be liable for repairs to the highway if the contractor's work is substandard and requires attention.

(3) Governmental Entity Pools

A Governmental Entity Pool is an alternative surety for local agencies and public utilities. For-profit utilities are not eligible for Entity Pool coverage.

Generally, an Entity Pool only provides liability coverage for Participating Members' third-party damages, such as bodily injury or property damage, resulting from members' negligent acts. Coverage is not normally provided for performance. In order for a utility to use an Entity Pool as a surety for highway utility installation purposes, the Entity Pool must be willing to provide, by Resolution, performance coverage in lieu of a performance bond on behalf of its Participating Members.

(a) Entity Pool Eligibility – To meet WSDOT's entity pool surety requirements, an organization must:

- Be a local agency, such as a city or county, or a public utility.
- Be a participating member in a joint self-insured local government property/liability program.
- Have the approval and oversight of the State Risk Manager in the Office of Financial Management (OFM), as provided in [RCW 48.62](#).
- Operate under the rules of [WAC 82-60](#).
- Be listed on the OFM Risk Management Division Local Government Self-Insurance Program.

(4) Sureties for Other State Agencies

Sureties are not required for utility accommodations involving other state agencies.

(5) Sureties for U.S. Government Agencies

Sureties are not required for federal agency utility accommodations.

(6) Surety Requirements

The following are minimum requirements for all sureties submitted:

- Must be an original surety document.
- Escrow Agreement must be from a legally licensed banking institution.
- Escrow Agreement must be stamped, signed, and notarized by a valid Notary Public licensed to do business in the state of Washington.
- Bonds must be issued from a bonding agent licensed within the state of Washington. State forms may be used by the bonding agent, or bonding agents may use their own forms, provided all information contained on the state form is contained in the agent form.
- Entity Pool sureties must be self-insured local government property/liability programs that have the approval and oversight of the State Risk Manager in the Office of Financial Management as provided in [RCW 48.62](#) and operate under the rules of [WAC 82-60](#).

(7) Surety Approval

The Region Utilities Engineer approves and maintains individual sureties. The HQ Utilities, Railroad, and Agreements Manager approves and maintains blanket sureties. The HQ Utilities Unit also maintains a Holder List of approved blanket sureties that is updated and published regularly.

(8) Surety Amounts

- (a) **Individual Surety Minimum Amounts** – Individual bonds and Assignment of Escrow Accounts shall be a minimum of \$1000. Surety amounts may be higher if deemed necessary or prudent by WSDOT to enable recovery of foreseeable expenses. WAC 468-34-020(3)
- (b) **Blanket Surety Minimum Amounts** – Blanket Bonds shall be a minimum of \$10,000. However, an individual surety may be used to supplement a blanket surety on a case-by-case basis for individual utility installations if deemed necessary or prudent by WSDOT. WAC 468-34-020(3)
- (c) **Additional Surety** – The Region Utilities Engineer should use individual discretion when considering requiring increased or additional surety amounts beyond the minimum. Reasons or conditions for requiring increased amounts include, but are not limited to:
 - Open cuts of the paved roadway.
 - Other Category 1 installations.
 - Demonstrated poor work performance issues.

- Scope of work, such as large or high-impact projects.
- Roadway crossings other than open cuts.
- Bridge attachment installations.

WSDOT may increase surety amounts for any reasonable situation deemed high risk to the continued safety or operation of department facilities.

(9) Surety Duration

To ensure authorized utility work has been done to WSDOT's satisfaction, all sureties remain in effect until Completion of Construction, as follows:

WAC 468-34-020(3)

- (a) **Installations Outside the Roadway** – Sureties for work outside the roadway prism shall be maintained for a minimum period of one year after the date of completion of construction. Drainage, reestablishment of vegetation, or other issues may extend this time period on a case-by-case basis (see below).

WAC 468-34-020(3)

- (b) **Open Cuts of Traveled Lanes or Shoulders** – Sureties for work involving disturbance of the roadway prism shall be maintained for a minimum period of two years after the date of Completion of Construction. This is to ensure no settling or other secondary damage has occurred as a result of the installation.

WAC 468-34-020(3)

- (c) **Drainage, Vegetation Reestablishment, or Other Special Situations** – Sureties for special situations shall be held as needed for the situation until Completion of Construction. For example, sureties for utility work requiring revegetation may be held until revegetation has taken hold to WSDOT's satisfaction. Specific conditions and expectations defining when a surety may be released should be clearly identified in the accommodation document provisions. Identify contact persons in Special Provision No. 1, when used.

(10) Surety Release

- (a) **Individual Sureties** – The surety holder or surety agent must request a surety release in writing from WSDOT. Upon satisfactory review, a letter authorizing the release of the surety must be sent to the bonding agent or banking institution where the surety is held. A copy of the letter should also be sent to the surety holder.
- (b) **Blanket Sureties** – Requests for release of blanket sureties must be made in writing to the State Utilities Engineer. A Notice of Request for Release of Blanket Surety must be distributed to each Region Utilities Engineer for review of installations within their regions. All utility installations installed by the Surety Holder must be reviewed to ensure the Surety Duration has been satisfied.

(11) Changing Blanket Surety

Unless authorized by WSDOT, utilities making a change in surety agents are required to maintain a surety at all times during the surety transition.

(12) Surety for Utility Maintenance Plans

A surety is required for all Utility Maintenance Plans. If the utility has a current blanket surety on file, the Maintenance Plan surety requirement may be considered satisfied. If no blanket surety is on file, an Individual Surety must be obtained before a utility can be allowed access to the highway operating right of way to conduct maintenance, regardless of whether an approved Maintenance Plan is on file.

equipment. Include a note in Exhibit B, after the Agreement Cost Summary, explaining the mobilization costs used in the agreement.

6. **Sales Tax Applicability** – Use the following guide to determine whether state sales tax is appropriate as an added item in the cost estimate. Use the Control Section Tax Tables (contact region Program Management for the current tables or rates) to determine the applicable sales tax rate. This is especially useful in determining whether sales tax is appropriate for work to be done inside the corporate limits of a city.

Conditions	Highway Owned by the State	Highway Not Owned by the State
The readjustment of utilities by utility forces at state expense (no sale made).	No	No
The readjustment of utilities by a contractor procured by the utility at state expense.	Yes	No
The readjustment of utilities by WSDOT's contractor at WSDOT's expense.	Yes	No
The readjustment of utilities by WSDOT's contractor at the utility's expense.	Yes	Yes

Sales Tax Applicability

Figure 200-1

To further clarify when sales tax should be added to the estimate, see Sections 107.2(1) and 1-07.2(2) of the *Standard Specifications for Road, Bridge, and Municipal Construction*.

7. **Engineering Costs** – Engineering costs for Work by State Agreements are computed as a proration of the total cost of the agreement to the total cost of the project. The engineering percentage rate to be used for estimating and progress payment purposes shall be taken from the *Plans Preparation Manual*. Include a note in Exhibit B, after the Agreement Cost Summary, explaining the engineering costs used in the agreement.
8. **Administrative Overhead**
- Indirect Cost Rate** – When WSDOT performs work for a utility, WSDOT shall apply its current Indirect Cost Rate to the total project costs. The current Indirect Cost Rate is calculated by the HQ Division of Accounting & Financial Services (AFS). New rates must be approved by FHWA prior to WSDOT being able to charge them. The rates are then effective during the current federal fiscal year, which is July 1 through June 30 of the following year.
 - Reciprocating Overhead Agreement** – If the utility is owned and operated by a municipality, and a Reciprocating Overhead Agreement¹ exists between the municipality and WSDOT, then the Indirect Cost Rate

¹ In a Memorandum from the Chief Engineer on April 29, 2010, the department was instructed that as of July 1, 2011, these agreements are no longer in effect, and as of June 2013, the use of Overhead Agreements will be discontinued.

is not applied. Include a note in Exhibit B, at the end of the Agreement Cost Summary, explaining that the Indirect Cost Rate was not applied to the agreement costs due to the existence of a Reciprocating Overhead Agreement. Show the agreement number and the effective date.

Regions request approval for new Reciprocating Overhead Agreements from the HQ AFS. New agreements will not be approved by the AFS unless WSDOT will actually receive a benefit by doing so. New agreements will also not be approved solely for the benefit of the city, town, or county. The region Accounting Office maintains a current list of Reciprocating Overhead Agreements.

9. **Cost Sharing** – When WSDOT and the utility share the cost of the relocation, the method of establishing each party’s share must be shown in Exhibit B. Show the shared costs in percentages using one of the following two methods:

- The percentage was established by comparing cost estimates of work for which each party is responsible.
- The percentage was established by comparing the length of the facility for which each party is responsible. This is acceptable only if the construction features are reasonably similar for each party’s portion of the facility.

The first method is preferred because it eliminates the impact that variables can have on the cost of the work. Exhibit B should note that this percentage split is fixed and shall be applied to the actual cost of the work.

10. **Agreement Summary Sheet** – A page titled “Agreement Summary Sheet” may be included as the last page of Exhibit B of a Construction Agreement or an Agreement Amendment. The Agreement Summary Sheet will contain all costs attributed to a single agreement number, such as the original Construction Agreement and all subsequent Agreement Amendments. Following is an example of information on an Agreement Summary Sheet:

UT 97301 Construction Agreement	\$25,000
UT 97301 Amendment No. 1 Construction Agreement	\$15,000
UT 97301 Amendment No. 2 Construction Agreement	\$10,000
Total to Date	\$50,000

- (c) **Exhibit C: Plans** – Maps and plan sheets included as part of a Construction Agreement are labeled as Exhibit C. The plans are a necessary and valuable part of the agreement and should be prepared with the same care and attention to detail as WSDOT’s highway project plans. Plan exhibits must show the highway centerline and stationing, existing right of way line, new right of way line, and limited access line. If the utility work is involved in a current proposed highway project, the highway project plans may be used in place of the current right of way plan or combined right of way/limited access plans.
- Show existing facilities that are (1) to remain in place and in use, or (2) to remain in place but be deactivated (or abandoned, under limited circumstances), but still owned by the utility.

- 900.01 General
- 900.02 Clear Zone vs. Control Zone
- 900.03 Control Zone Objectives
- 900.04 Definitions
- 900.05 Application
- 900.06 Control Zone Distance
- 900.07 Recovery Area
- 900.08 Supplemental Utility Design Information
- 900.09 Project Applications
- 900.10 Completing the Utility Object Relocation Record
- 900.11 Variance
- 900.12 Variance Request for Location I Objects
- 900.13 Reclassification Request for Location II Objects
- 900.14 The 5/15 Rule for Location II Objects

900.01 General

Washington State's Strategic Highway Safety Plan (SHSP) establishes strategies to reduce traffic fatalities and serious injuries along state highways, and identifies utility objects, specifically utility poles, as significant roadside hazards. This chapter addresses the objective of eliminating utility object collisions in accordance with the SHSP and provides guidance on the placement of aboveground utilities within Washington State Department of Transportation (WSDOT) highway rights of way. Further information regarding the SHSP can be found at:

 <http://targetzero.com/pdf/targetzeroplan.pdf>

900.02 Clear Zone vs. Control Zone

Clear Zone is defined in the WSDOT *Design Manual* as “The total roadside border area, available for use by errant vehicles, starting at the edge of the traveled way and oriented from the outside or inside shoulder (in median applications) as applicable...”

From a technical standpoint, Control Zone and Clear Zone are synonymous in that the criteria and methodology used to calculate the two are identical. The distinction is one of policy in applying measures to achieve compliance. The differing policies are based on the recognition that accommodation of utility facilities within the state highway right of way is in the public interest when such use and occupancy do not adversely affect highway operations or safety. Control Zone policy recognizes that practicable options for utility accommodation are sometimes limited to the right of way under WSDOT's control and allows for certain measures, including variance approvals and reclassification of utility objects, with due consideration for the safety of highway users.

It is critical for WSDOT staff to work cooperatively with the utilities in implementing these guidelines during both accommodation and project delivery coordination, including helping utilities to understand the methodologies involved with Control Zone calculation and ensuring any necessary corrective action or other remedies specified in this chapter are implemented.

900.03 Control Zone Objectives

The hierarchy of Control Zone objectives is as follows:

- **Objective 1:** Locate all utility objects outside the Control Zone.
- **Objective 2:** If compliance with Objective 1 is not possible, correct the object with the use of an alternative measure. Unless otherwise specified in [900.14](#), all Location I Objects shall be adjusted to meet either Location II or Location III criteria.
- **Objective 3:** If compliance with Objective 1 and Objective 2 is not possible, individual Location II Objects may be reclassified to Location III Objects if justified by a utility-provided Engineering Analysis or application of the “Cost Effective Selection Procedure.”

900.04 Definitions

See [Appendix A](#), Glossary.

900.05 Application

All new utility objects will be constructed outside the Control Zone unless they are covered by a variance (discussed below) or are designated as Location III Objects. In addition, utilities will be required to relocate or mitigate existing objects within the Control Zone by addressing existing objects during WSDOT highway projects, utility reconstruction, and Franchise Renewal/Consolidation, or if the department determines that any existing objects must be relocated or mitigated for the safety of highway users.

(1) Utility Construction or Reconstruction

During utility construction or reconstruction, the utility will locate or relocate all utility objects to outside the Control Zone unless they are classified as Location III Objects or a variance is granted.

(2) Highway Improvement Projects

During the planning phase of state highway improvement projects, WSDOT will inform the utility that it is required to adjust utility objects that, either prior to or as the result of the project, are located in the Control Zone. For WSDOT highway safety projects (such as I2 projects), additional relocation or mitigation for objects outside the Control Zone may be necessary. In these cases, WSDOT will work with the utilities and adjoining property owners to determine available options and coordinate any necessary corrective action.

WSDOT will notify the utilities of upcoming highway improvement projects as early as possible. During the project development phase, the utility will be advised of the scheduled project advertising date and of those utility objects requiring relocation.

(3) Franchise Renewal and Consolidation

Prior to renewal or consolidation of franchises that include aboveground utility objects, the utility shall identify all Location I and Location II Objects within the proposed Franchise Renewal or Consolidation and submit a Corrective Action Plan and schedule of relocation, reclassification, or countermeasures for WSDOT review and approval. It is expected that a utility company will budget resources to accomplish the work necessary to renew franchise documents, including bringing its facilities in compliance with Control Zone requirements.

900.06 Control Zone Distance

The Control Zone distance for any particular highway segment varies according to the posted speed, traffic volumes, and sideslopes of the highway. This section contains methods and supporting information on determining the Control Zone distance for a particular location along the highway, including:

- General guidance for determining Control Zone distance.
- Different methods of Control Zone calculation and examples applicable to various highway geometric conditions (Conditions 1 through 6).
- Clear Zone Distance Table (see [Figure 900-9](#)) to be utilized in Control Zone calculation.
- Recovery Area Formula for use with Conditions 4 and 6.

(1) General Guidance for Determining Control Zone Distance

- All distances are measured from the edge of the through lane, extending outward perpendicular to the traveled way.
- Roadside is the distance measured from the edge of the through lane to the beginning of the backslope, as in Conditions 2, 3, and 4, and from the edge of the through lane to the toe of the slope, as in Condition 6.
- Slope ratios are expressed, in feet, as 3H:1V, 4H:1V, 5H:1V. The first number represents the horizontal distance and the second represents the vertical distance (see [Figure 900-1](#)).

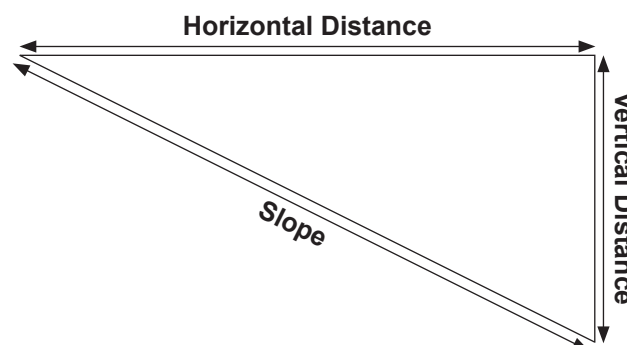

Slope Ratio
Figure 900-1

- For fill sections where the sideslope area includes multiple slope ratios of 4H:1V or flatter (Condition 5), the applicable slope ratio should be determined based on averaging the slope ratios according to the following method:

Slope Averaging

- $A1/A2 + B1/B2 = C$
- Slope Average = $\frac{A1+B1}{C}$

Where:

- A1 = width of the first slope section, measured from the beginning of the sideslope to the beginning of the next slope section
- A2 = horizontal value in the slope ratio corresponding with A1
- B1 = width of the next slope section, measured from the beginning of the section to the face of utility object
- B2 = horizontal value in the slope ratio corresponding with B1

Example:

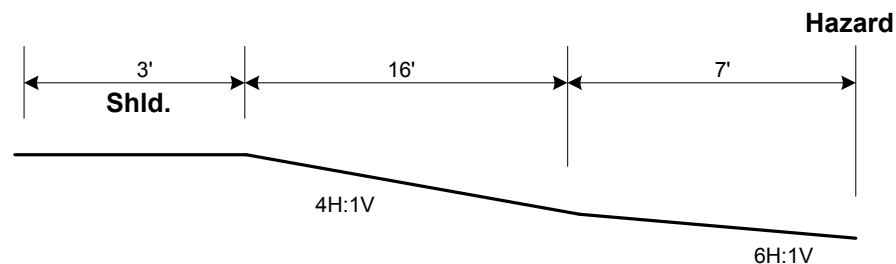

Slope Averaging

Figure 900-2

$$A1 = 16, A2 = 4, B1 = 7, B2 = 6$$

- $16/4 + 7/6 = 4 + 1.17 = 5.17$
 - $23/5.17 = 4.45$ Average slope = 4:1
- The Recovery Area Formula (see [900.07](#)) is normally used when the cut section foreslope (Condition 4) or the fill section sideslope (Condition 6) is steeper than 4H:1V, but not steeper than 3H:1V. When using the Recovery Area Formula to calculate the Clear Zone, if the highway section includes a ditch, slope data for the backslope must also be collected and factored into the formula.
 - When auxiliary lanes for parking, vehicle pull-out, turning, or storage are present, the Control Zone begins at the edge of the through lane. When the Recovery Area Formula is used, the shoulder width distance will include these auxiliary lane widths.
 - For managed access city streets that are part of state highways, cities may adopt Control Zone standards that vary from the requirements of this chapter (see [RCW 47.24.020](#)).

(2) Determining the Control Zone Distance for Various Highway Geometric Conditions

Control Zone distance at a particular location is determined using the following methods. Choose one of the six Conditions with matching highway section characteristics and follow the listed steps and instructions. The table referred to in this section is the Clear Zone Distance Table (see [Figure 900-9](#)).

(3) Cut Sections: Conditions 1, 2, 3, and 4

(a) Cut Section: Condition 1

- No ditch
- Backslopes of 3H:1V or flatter

The Control Zone is read directly from the table based on posted speed, average daily traffic (ADT), and backslope.

Step 1: Locate posted speed

Step 2: Locate ADT

Step 3: Locate backslope

Step 4: Read CZ directly from table

Example:

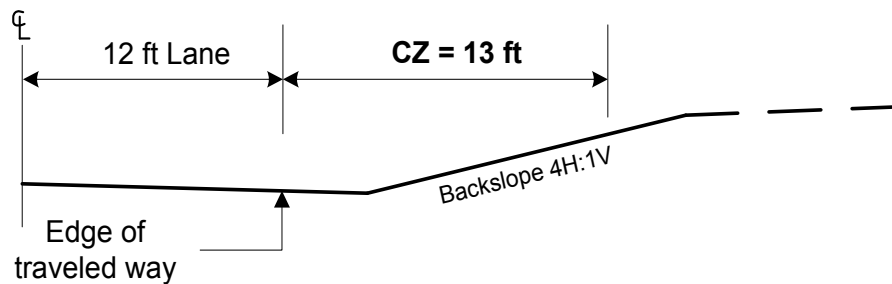

- Step 1: Speed is 45 mph
 Step 2: Traffic is 1900 ADT
 Step 3: Backslope is 4H:1V
 Step 4: Read 13 feet directly from table

Control Zone = 13 feet

Control Zone Cut Section: Condition 1

Figure 900-3

(b) Cut Section: Condition 2

- Ditch foreslopes of 4H:1V or flatter
- For all ditch backslopes, use 10H:1V cut section in calculations

The Control Zone distance is the greater of:

1. Read directly from the table based on posted speed, average daily traffic (ADT), and a backslope of 10H:1V.

Step 1: Locate posted speed

Step 2: Locate ADT

Step 3: Use backslope of 10H:1V

Step 4: Read directly from table

2. Five feet beyond the roadside width.

Step 1: Locate roadside width

Step 2: Add 5 feet to the roadside width

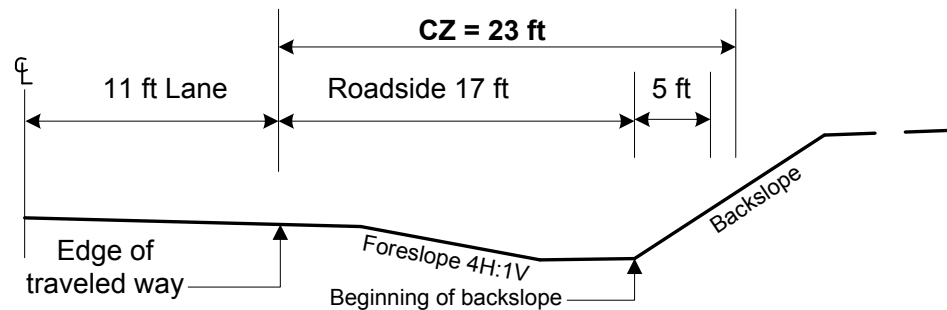
Example:

1. Step 1: Speed is 55 mph
Step 2: Traffic is 4200 ADT
Step 3: Foreslope 4H:1V or flatter: use a backslope of 10H:1V (from table)
Step 4: Read 23 feet directly from table

2. Step 1: Roadside width is 17 feet
Step 2: 17 feet plus 5 feet = 22 feet

Solution = Greater of: 1. = 23 feet or 2. = 22 feet

Control Zone = 23 feet

Control Zone Cut Section: Condition 2

Figure 900-4

(c) Cut Section: Condition 3

- Ditch foreslope is steeper than 4H:1V
- Ditch backslope is steeper than 3H:1V

The Control Zone distance is established at 10 feet beyond the beginning of backslope (roadside width).

Step 1: Locate roadside width

Step 2: Add 10 feet to the beginning of backslope (roadside width)

Example:

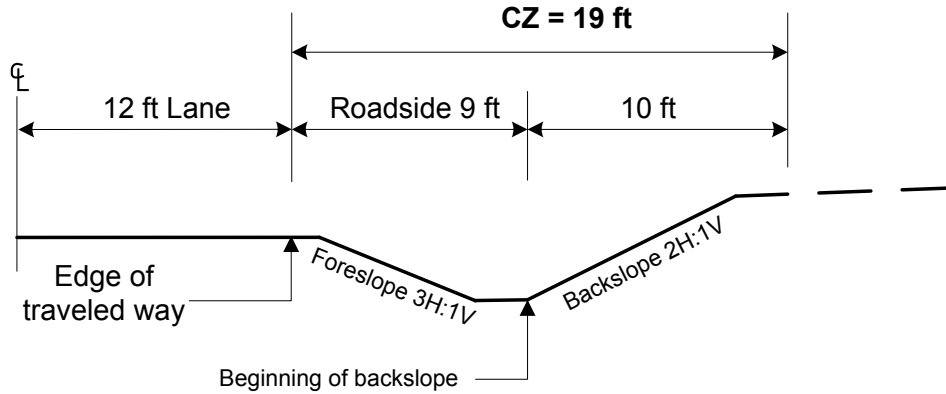

Step 1: Roadside width is 9 feet
 Step 2: 9 feet plus 10 feet = 19 feet
 Control Zone = 19 feet

Control Zone Cut Section: Condition 3

Figure 900-5

(d) Cut Section: Condition 4

- Ditch foreslope is steeper than 4H:1V, but not steeper than 3H:1V*
- Ditch backslope is 3H:1V or flatter

*Note: For steeper slopes, the Recovery Area Formula may be used as a guide if the difference in elevation between the edge of travelled way and bottom of ditch is 10 feet or less.

The Control Zone distance is the recovery area calculated using the Recovery Area Formula (see 900.07).

Step 1: Locate posted speed

Step 2: Locate ADT

Step 3: Locate backslope

Step 4: Read CZ distance from table

Step 5: Locate roadside width

Step 6: Locate shoulder width

Step 7: Use Recovery Area Formula

Example:

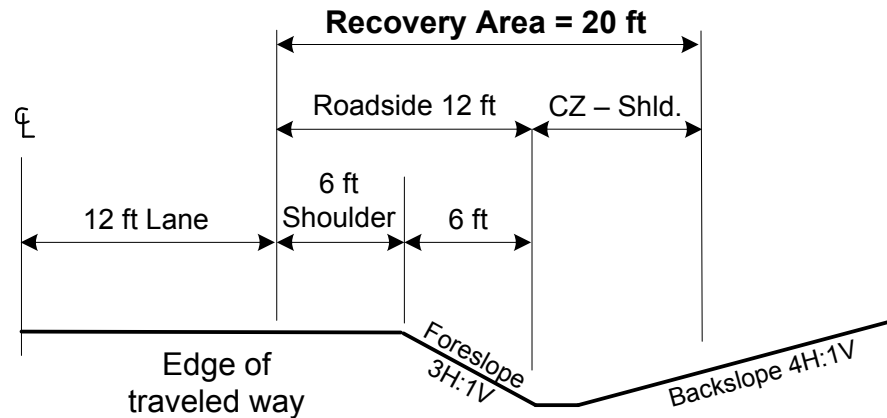

Step 1: Speed is 40 mph

Step 2: Traffic is 3000 ADT

Step 3: Backslope is 4H:1V

Step 4: Read from table, CZ is 14 feet

Step 5: Roadside width is 12 feet (6-foot shoulder + 6-foot horizontal distance)

Step 6: Shoulder width is 6 feet

Step 7: $(12 \text{ feet}) + (14 \text{ feet} - 6 \text{ feet}) = 20 \text{ feet}$

Control Zone = 20 feet

Control Zone Cut Section: Condition 4

Figure 900-6

(4) Fill Section: Conditions 5 and 6**(a) Fill Section: Condition 5**

- Sideslope is 4H:1V or flatter

The Control Zone distance is read directly from the table based on posted speed, sideslope, and average daily traffic (ADT).

Step 1: Locate posted speed

Step 2: Locate ADT

Step 3: Locate sideslope (use slope averaging formula; see 900.06(1) when sideslope ratio varies)

Step 4: Read CZ directly from table

Example:

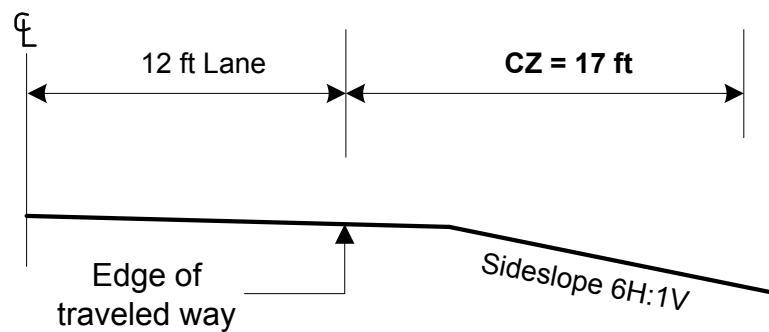

- Step 1: Speed is 50 mph
 Step 2: Traffic is 320 ADT
 Step 3: Sideslope is 6H:1V
 Step 4: Read 17 feet directly from table
Control Zone = 17 feet

Control Zone Fill Section: Condition 5
Figure 900-7

(b) Fill Section: Condition 6

- **Sideslope is 3H:1V or steeper***

The Control Zone distance is the recovery area, calculated using the Recovery Area Formula (see 900.07).

*Note: Recovery Area Formula normally applies to slopes steeper than 4H:1V, but not steeper than 3H:1V. For steeper slopes, the Recovery Area Formula may be used as a guide if the embankment height is 10 feet or less.

For installations where the sideslope is steeper than 3H:1V and the fill height is greater than 10 feet, consult [Figure 900-16](#), Guidelines for Embankment Barrier. If embankment barrier is not recommended, Control Zone is the Recovery Area.

Recovery Area = shoulder width + horizontal nonrecoverable sideslope distance (roadside width) + (Control Zone distance from table – shoulder width)

- Step 1:** Locate posted speed
Step 2: Locate ADT
Step 3: Locate existing ground sideslope
Step 4: Read CZ distance from table
Step 5: Locate roadside width
Step 6: Locate shoulder width
Step 7: Use Recovery Area Formula

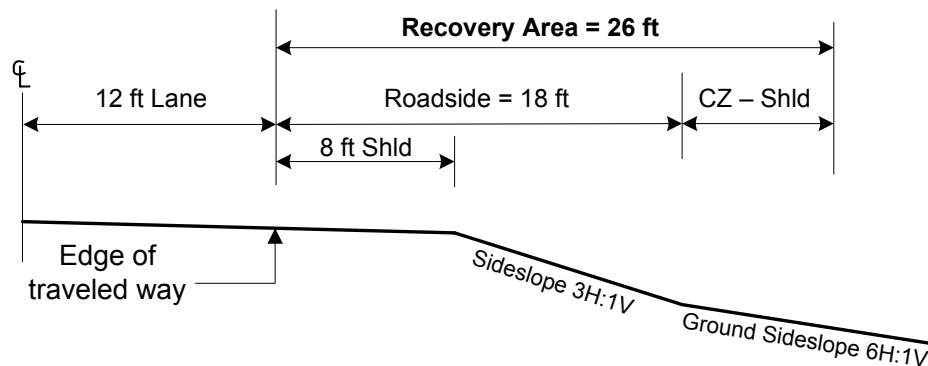
Example:

- Step 1: Speed is 40 mph
 Step 2: Traffic is 3000 ADT
 Step 3: Existing ground sideslope is 6H:1V
 Step 4: Read from table, CZ is 16 feet
 Step 5: Roadside width is 18 feet
 Step 6: Shoulder width is 8 feet
 Step 7: $(18 \text{ feet}) + (16 \text{ feet} - 8 \text{ feet shld}) = 26 \text{ feet}$

Control Zone = 26 feet

Note: For positive (+) ground sideslopes, use Condition 3 or 4.

Control Zone Fill Section: Condition 6

Figure 900-8

Clear Zone Distances for State Highways Outside Incorporated Cities*
(In feet, from edge of traveled way**)

Posted Speed mph	Average Daily Traffic	Cut Section (Backslope) (H:V)						Fill Section (H:V)					
		3:1	4:1	5:1	6:1	8:1	10:1	3:1	4:1	5:1	6:1	8:1	10:1
35 or Less		The Control Zone distance is 10 feet											
40	Under 250	10	10	10	10	10	10	***	13	12	11	11	10
	251-800	11	11	11	11	11	11	***	14	14	13	12	11
	801-2000	12	12	12	12	12	12	***	16	15	14	13	12
	2001-6000	14	14	14	14	14	14	***	17	17	16	15	14
	Over 6000	15	15	15	15	15	15	***	19	18	17	16	15
45	Under 250	11	11	11	11	11	11	***	16	14	13	12	11
	251-800	12	12	13	13	13	13	***	18	16	14	14	13
	801-2000	13	13	14	14	14	14	***	20	17	16	15	14
	2001-6000	15	15	16	16	16	16	***	22	19	17	17	16
	Over 6000	16	16	17	17	17	17	***	24	21	19	18	17
50	Under 250	11	12	13	13	13	13	***	19	16	15	13	13
	251-800	13	14	14	15	15	15	***	22	18	17	15	15
	801-2000	14	15	16	17	17	17	***	24	20	18	17	17
	2001-6000	16	17	17	18	18	18	***	27	22	20	18	18
	Over 6000	17	18	19	20	20	20	***	29	24	22	20	20
55	Under 250	12	14	15	16	16	17	***	25	21	19	17	17
	251-800	14	16	17	18	18	19	***	28	23	21	20	19
	801-2000	15	17	19	20	20	21	***	31	26	23	22	21
	2001-6000	17	19	21	22	22	23	***	34	29	26	24	23
	Over 6000	18	21	23	24	24	25	***	37	31	28	26	25
60	Under 250	13	16	17	18	19	19	***	30	25	23	21	20
	251-800	15	18	20	20	21	22	***	34	28	26	23	23
	801-2000	17	20	22	22	23	24	***	37	31	28	26	25
	2001-6000	18	22	24	25	26	27	***	41	34	31	29	28
	Over 6000	20	24	26	27	28	29	***	45	37	34	31	30
65	Under 250	15	18	19	20	21	21	***	33	27	25	23	22
	251-800	17	20	22	22	24	24	***	38	31	29	26	25
	801-2000	19	22	24	25	26	27	***	41	34	31	29	28
	2001-6000	20	25	27	27	29	30	***	46	37	35	32	31
	Over 6000	22	27	29	30	31	32	***	50	41	38	34	33
70	Under 250	16	19	21	21	23	23	***	36	29	27	25	24
	251-800	18	22	23	24	26	26	***	41	33	31	28	27
	801-2000	20	24	26	27	28	29	***	45	37	34	31	30
	2001-6000	22	27	29	29	31	32	***	50	40	38	34	33
	Over 6000	24	29	31	32	34	35	***	54	44	41	37	36

*This figure also applies to limited access state highways in cities and median areas on managed access state highways in cities.

(See the [Design Manual](#) for guidance on managed access state highways within incorporated cities.)

**Traveled way: The portion of the roadway intended for the movement of vehicles, exclusive of shoulders and lanes for parking, turning, and storage for turning.

***When the fill section slope is steeper than 4H:1V, but not steeper than 3H:1V, the Control Zone distance is modified by the Recovery Area Formula and is referred to as the recovery area. The basic philosophy behind the Recovery Area Formula is that a vehicle can traverse these slopes but cannot recover (control steering); therefore, the horizontal distance of these slopes is added to the Control Zone distance to form the recovery area.

Clear Zone Distance Table

Figure 900-9

900.07 Recovery Area

Note: [Figure 900-10](#) clarifies the Recovery Area Formula.

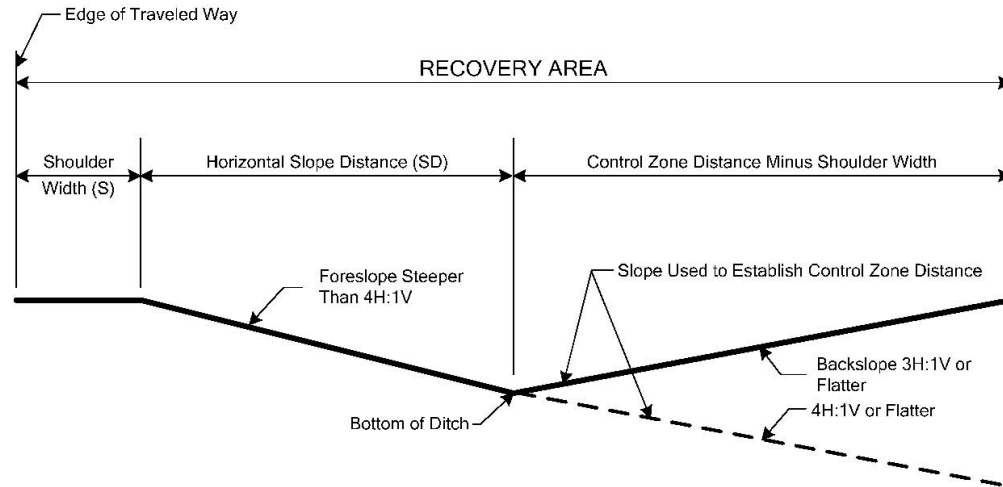

Formula:
 Recovery Area =
 (shoulder width) + (horizontal distance) + (Control Zone distance – shoulder width)

Recovery Area
Figure 900-10

Example

Fill Section (Slope 3H:1V or Steeper)	
Conditions	Speed – 45 mph Traffic – 3000 ADT Slope – 3H:1V
Criteria	Slope 3H:1V – Use Recovery Area Formula
RECOVERY AREA = 29 ft	
Recovery Area = (shoulder width) + (horizontal distance) + (Control Zone distance – shoulder width)	
29 feet =	8 + 12 + (17 – 8)

Recovery Area Calculation
Figure 900-11

900.08 Supplemental Utility Design Information

The following items are provided as a guide to the utility industry for consideration during design and maintenance of its facilities.

(1) Horizontal Curves

If it is not necessary, do not place utility objects on the outside of horizontal curves.

(2) Public Grade Intersections

When possible, design the facility placing utility objects outside the turn radius area of public grade intersections (see [Figure 900-12](#)). If this is not possible, the facility should, at a minimum, be placed outside the Control Zone in relation to the state highway. If the intersecting road is a local agency roadway with a stop condition at the state highway intersection, the facility must be placed at least 10 feet from the edge of the travelled way for the portion of the local agency roadway leg within WSDOT ownership. If WSDOT ownership of the local agency roadway leg exceeds more than 250 feet back from the stop bar at the highway intersection, contact the HQ Utilities Unit for additional guidance. Applicable local agency standards shall apply outside of WSDOT-owned right of way.

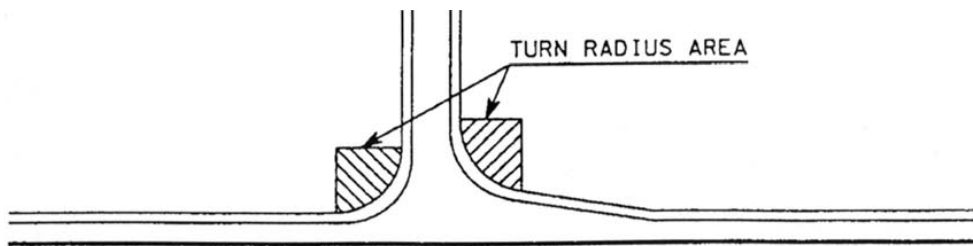

Intersection Radius Area

Figure 900-12

(3) Placement of Utility Objects Behind Barriers

Do not place objects within the deflection distance of any barrier used.

(4) Service Poles

Place service poles on owners' property, not state right of way. Consideration should be given to placing the service pole as far as possible from the highway right of way—at a minimum, outside the Control Zone.

(5) Pole Design

When Control Zone requirements within the highway right of way are tight, consideration should be given to alternative pole designs that may allow construction at or close to the right of way line (see [Figure 900-13](#)).

(6) Guy Poles/Wires

Guy poles and/or wires are not to be installed between the pole line and highway lanes unless the guy pole/wire is outside the Control Zone. Guy and anchor wires are considered hazard objects.

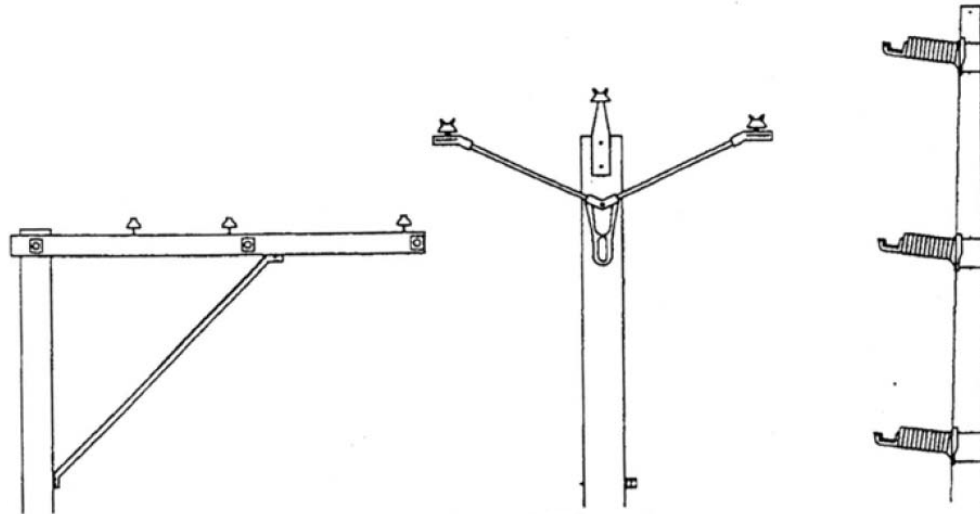

Alternative Pole Designs
Figure 900-13

(7) Utility Location Markers

Markers used to identify or protect utility facilities, such as a telephone pedestal, may not be larger than a 4 × 4 (16 sq. inches) wood post unless drilled to accommodate breakaway. Solid markers, such as concrete, may not be used. Telephone pedestals that meet the breakaway criteria are acceptable within the Control Zone.

Post Size	Hole DIA
4 × 4	—
4 × 6	1½ inch
6 × 6	2 inch
6 × 8	3 inch

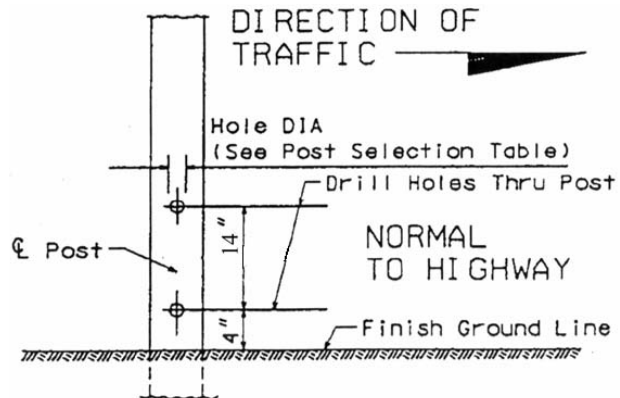

Note: Posts that are larger than 6 × 8 require barrier protection when located within the Control Zone. (See the [Standard Plans](#) for further guidance.)

Wood Post Breakaway Details
Figure 900-14

900.09 Project Applications

(1) New Utility Facility Construction

- (a) The utility constructs a new line or extends an existing line within highway right of way.
1. New utility objects will comply with Objective 1 or 2 (see [900.03](#)).
 2. No consideration of Objective 3 or 4 (see [900.03](#)) will be given until all alternative measures have been investigated and determined not feasible.
 3. The utility will submit to WSDOT the following data if applicable:
 - Franchise/Franchise Amendment/Permit applications.
 - Mitigation proposals for existing objects, including plans.
 - Submittals supporting variance or object reclassification requests, as specified in [900.13](#).
 - A completed copy of the Utility Object Relocation Record listing new utility objects.

(2) Existing Utility Reconstruction

- (a) The utility replaces twenty-five percent (25%) or more of the existing poles or towers within any mile. Periodic pole or tower replacement is not included.
1. Utility objects will comply with Objective 1 or 2 (see [900.03](#)).
 2. No consideration of Objective 3 or 4 (see [900.03](#)) will be given until all alternative measures have been investigated and determined not feasible.
 3. The utility will submit to WSDOT the following data if applicable:
 - Franchise Amendment/Permit applications.
 - Mitigation proposals for existing objects, including plans.
 - Submittals supporting variance (see [900.11](#)) or object reclassification requests, as specified in [900.13](#).
 - A copy of the completed Utility Object Relocation Record.

(3) Utility Relocation Required by WSDOT Improvement Projects

- (a) Conditions: WSDOT may address individual safety items.
1. WSDOT will conduct an accident analysis to determine spot safety improvement needs.
 2. Any individual Location I or Location II Objects that demonstrate a need for adjustment will be adjusted to comply with Objective 1 or 2 (see [900.03](#)) in conjunction with the project.
 3. No consideration of Objective 3 or 4 (see [900.03](#)) will be given until all alternative measures have been investigated and determined not feasible.
 4. At the time the project preliminary estimate is prepared, WSDOT will notify the utility of the project and request that the utility commit to a course of action.

5. The utility will submit to WSDOT the following data if applicable:
 - Franchise/Franchise Amendment/Permit applications.
 - Mitigation proposals for existing objects, including plans.
 - Submittals supporting variance (see 900.11) or object reclassification requests, as specified in 900.13.
 - A copy of the completed Utility Object Relocation Record.
- (b) Conditions: WSDOT addresses safety items.
1. The utility will adjust all Location I Objects to comply with Objective 1 or 2 (see 900.03). Location II Objects will be adjusted to the same extent as other safety work on the project.
 2. No consideration of Objective 3 or 4 (see 900.03) will be given until all alternative measures have been investigated and determined not feasible.
 3. At the time the project preliminary estimate is approved, WSDOT will notify the utility of the project scope and the Location I Object and Location II Object responsibility.
 4. When the project Design Summary is completed, WSDOT will request that the utility adjust all Location I Objects and selected Location II Objects.
 5. The utility will submit to WSDOT the following data if applicable:
 - Franchise Amendment/Permit applications.
 - Mitigation proposals for existing objects, including plans.
 - Submittals supporting variance (see 900.11) or object reclassification requests, as specified in 900.13.
 - A copy of the completed Utility Object Relocation Record.

(4) Process Responsibilities

Process	Responsibility
Systematic Mitigation	Utility
Location I Variance/Mitigation Documentation	Utility and WSDOT (Region)
Location II Reclass./Mitigation Documentation	Utility and WSDOT (Region)
Location II Reclass./Mitigation Approval	WSDOT (HQ)
Location II Reclass./Approval – The 5/15 Rule	WSDOT (Region)
Engineering Studies	Utility and WSDOT (Region)
Cost-Effective Selection Procedure	Utility and WSDOT (Region)
WSDOT Project Notification	WSDOT (Region)
WSDOT Project Control Zone Compliance Letters	WSDOT (Region)

Process Responsibilities

Figure 900-15

900.10 Completing the Utility Object Relocation Record

A completed Utility Object Relocation Record (see [Appendix B](#)) form shall accompany any utility submittals to WSDOT as part of a Franchise or Permit Amendment, Franchise Renewal/Consolidation, or highway project-related relocation coordination when objects exist or are proposed to be in Location I or II. Following is the information needed on the form.

(1) Form Headings

Enter the utility owner and location and other identification information on the top left side of the form.

Enter the milepost limits beside the proper type of construction on the top right side of the form.

(2) Existing Object Information

Identify the utility object by entering the milepost, pole or object number, location left or right of highway centerline (left or right is determined facing the increasing highway milepost), type of object (i.e., transmission, guy), and whether it is owned, jointly owned, or leased.

(3) Roadway Data

The speed, average daily traffic (ADT), and the right of way width from centerline can be obtained from the region Utilities Office. Also, ADTs can be found in the Annual Traffic Report and highway speed in the State Highway Log. These can be obtained on the Statewide Travel and Collision Data Office website:

www.wsdot.wa.gov/mapsdata/stcdo_home.htm

(4) Field Measurements

Enter the slope and distance measurements required to calculate the Control Zone distances (see [900.06](#)).

(5) Control Zone Calculations

From the Control Zone Distance section (see [900.06](#)):

- Enter the Condition number that was used to calculate the Control Zone distance.
- Enter the calculated Control Zone distance.
- Enter whether the object is Location I or Location II.

Notice that the Location III Objects do not need to be entered on the form.

(6) Planned Object Correction

This section is used by the utility to record, on the Utility Object Relocation Record form (see [Appendix B](#)), its decision on how the utility object will be corrected.

- For utility objects that will be relocated outside the Control Zone, in compliance with Objective 1 (see [900.03](#)), mark the relocated distance in the Reloc. Dist column.

- For utility objects that will be corrected with the use of an alternative measure, in compliance with Objective 2 (see [900.03](#)), mark the Alternate Measure column.
- If mitigation is the alternative measure chosen, justification for the use of mitigation and a plan showing proposed mitigation are required for WSDOT review and approval.
- For individual utility Location I Objects that cannot be relocated outside the Control Zone or corrected with the use of an alternative measure, and for which a variance will be requested, mark the LOC I VAR. column.
Note: Only in extreme cases will a variance be considered.
- To be considered for a variance, the utility must submit to WSDOT a request for a variance together with the required justification (see [120.14](#)).

For individual utility Location II Objects that cannot be relocated outside the Control Zone or corrected with the use of an alternative measure and for which a reclassification will be requested, mark the LOC II Reclass. column. Note: A reclassification will be considered only in cases where conditions such as right of way width, terrain, or other features make it impracticable to comply with Objective 1 or 2 (see [900.03](#)).

900.11 Variance

WSDOT recognizes that conditions may arise that make it impracticable to comply with Control Zone requirements. Variances from such compliance may be allowed on a case-by-case basis when clearly justified, as specified in the following sections.

Examples of conditions rendering compliance impracticable include:

- Inadequate right of way to accommodate utility objects outside the Control Zone.
- Physical limitations due to terrain or topography.

(1) *Utility Object Location Category Reference*

(a) Location I Utility Objects

Fixed utility objects located within the Control Zone in the following areas:

- The outside of horizontal curves where advisory speeds for the curve are 15 mph or more below the posted speed limit of that section of highway.
- Within the turn radius area of public road grade intersections.
- Where a barrier, embankment, rock outcropping, ditch, or other roadside feature is likely to direct a vehicle into a utility object.
- Closer than 5 feet horizontal beyond the edge of the usable shoulder.

(b) Location II Utility Objects

Fixed utility objects located within the Control Zone that are not classified as Location I or Location III Objects.

(c) Location III Utility Objects

Fixed utility objects that are:

- Located outside the Control Zone.
- Within the Control Zone and mitigated by an alternate countermeasure consistent with the state's *Utilities Accommodation Policy*.

900.12 Variance Request for Location I Objects

Compliance with the WSDOT Control Zone policy requires adjustment of all Location I Objects to meet Location II or III criteria. Exceptions may be granted only after a joint analysis and recommendation is completed by the region utilities engineer, region traffic engineer, and HQ utilities engineer. Reviews for this purpose will consider relevant highway operational and geometric factors, accident history, and assessment of possible mitigation strategies. Exceptions will be allowed only if it is determined, at the department's discretion, that no reasonable alternative measures are available, with safety being the primary consideration. These requests will be assessed on a case-by-case basis, and will require specific information and documentation from the utility as determined by the review team.

900.13 Reclassification Request for Location II Objects

Compliance with the WSDOT Control Zone Guidelines requires adjustment of Location II Objects to meet the following objectives:

- **Objective 1:** Locate all utility objects outside the Control Zone.
- **Objective 2:** If compliance with Objective 1 is not possible, correct the object with the use of an alternative measure.
- **Objective 3:** If compliance with Objectives 1 and 2 is not possible, individual Location II Objects may be reclassified to Location III Objects if justified by a utility-provided Engineering Analysis or application of the Cost-Effective Selection Procedure.

The utility will adjust Location II Objects to comply with Objective 1 or 2 (above).

WSDOT recognizes that conditions may arise that make it impracticable to comply with the maximum Control Zone. In these situations, a reclassification, if adequately supported, may be granted by WSDOT to allow utility objects to remain or to be installed within the Control Zone. No consideration of a reclassification will be given until all alternative measures have been investigated and determined not feasible.

To be considered for a reclassification, the utility will submit to WSDOT justification presented in either an Engineering Analysis or according to the Cost-Effective Selection Procedure, as specified below.

(1) Engineering Analysis

The Engineering Analysis must include, at a minimum, the following support data:

- (a) Justification that Location II Objects cannot be located outside the Control Zone.
 1. Provide evidence that installation in an alternate location outside the Control Zone or right of way is extremely difficult because of installation problems and/or it is unreasonably costly (show detailed cost comparison). Describe alternatives that were considered.

2. Submit pictures and typical cross sections. Cross sections shall include locations of proposed and existing utility objects, with reference to the edge of the traveled way.
- (b) Justification that Location II Objects cannot be corrected with the use of an alternative measure.
1. Locating on private easement outside the highway right of way.
Documentation that a good faith effort was made to obtain property rights outside of highway right of way is required. At a minimum, such documentation must include proof that an offer was made to the adjoining property owner based on fair market value, and that the offer was not accepted. Specific documentation for this purpose may vary depending on the nature of the proposal and at the discretion of the region utilities engineer.
 2. Putting utility line underground.
 3. Reducing the number of utility objects through joint use, increasing span lengths, and/or placing utility objects on only one side of the road.
 4. Increasing the lateral offset of utility objects from the edge of the traveled way.
 5. Mitigating utility objects by locating to an inaccessible area such as toward the top or on the top of cut slopes; installing protective devices such as berms, guardrails, traffic barriers, or impact attenuators; or using a breakaway design.

(2) Cost-Effective Selection Procedure

A Location II Object may be reclassified to Location III by meeting the following guidelines.

(a) Roadway Embankments

In a roadway embankment area, check [Figure 900-16](#). If guardrail is warranted, the object may be considered not cost-effective to relocate.

(b) Cost-Effective Selection Procedure

Complete the Cost-Effective Selection Procedure for objects not in an area recommended for guardrail using the AASHTO formula or the “ROADSIDE” or “[Roadside Safety Analysis Program \(RSAP\)](#)” programs. The lateral placement from the traveled way to the objects (for both the existing object and the relocated object) should be multiplied by the slope factors in the following table.

	Cut Slope				Fill Slope		
Slope Ratio	3H:1V	4H:1V	5V:1V	Flat	5H:1V	4H:1V	3H:1V
Slope Factor	1.5	1.2	1.1	1.0	0.8	0.7	0

Adjusted lateral distance = (lateral distance – shoulder width) × slope factor + shoulder width.

(Each lateral segment between the shoulder and the object should be adjusted by its slope factor.)

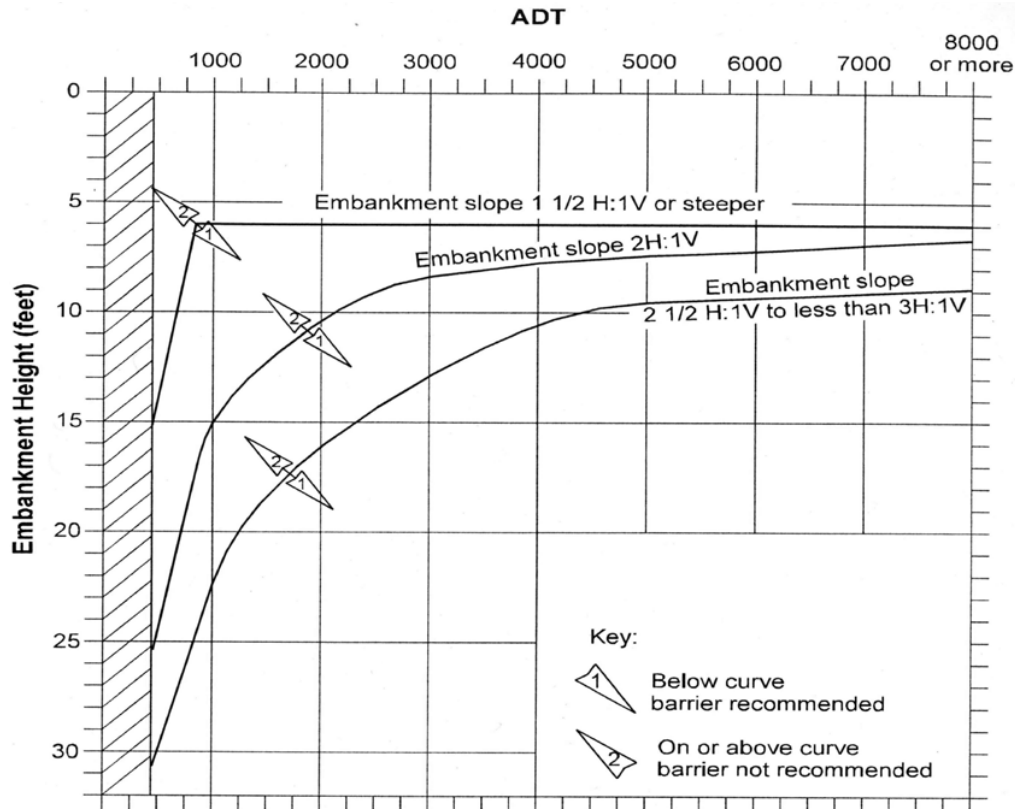

Note: Routes with ADTs under 400 may be evaluated on a case-by-case basis.

Guidelines for Embankment Barrier
Figure 900-16

(c) Variables for the Cost-Effective Selection Procedure (CESP)

The following AASHTO cost factors¹ will be used in the CESP formula until otherwise notified by WSDOT:

- Fatality collision: \$4,165,000
- Severe injury collision: \$350,000
- Moderate injury collision: \$75,000
- Slight injury collision: \$40,000
- Property Damage Only (PDO) collision: \$7,000

Use the following guidance when calculating with the CESP formula:

- **Traffic Growth Rate:** Use 5% unless otherwise indicated by WSDOT.
- **Severity Index:** 3.6 for 40 mph, 4.2 for 50 mph, 5.0 for 60 mph, and 6.0 for 70 mph.
- **Project Life:** Life of the existing or new pole.
- **Discount Rate:** The rate shall be equal to the weighted rate average cost of capital for each utility.

¹ The WSDOT Statewide Travel and Collision Data Office (STCDO) has applied inflation to the AASHTO cost factors to bring the numbers current as of July 2009.

- **Cost of Installation:** Determined by the utility for the installation being evaluated.
- **Cost of Repair:** Determined by the utility for the installation being evaluated.
- **Maintenance Cost per Year:** Determined by the utility for the installation being evaluated.
- **Salvage Value:** Determined by the utility for the installation being evaluated.

(d) Initial Encroachment Frequency

The initial encroachment frequency factors should be as follows:

Highway Type	Initial Encroachment Frequency (encroachment/mile/year)
Rural Interstate	0.0009 ADT
Rural Multilane Divided Highway	0.00059 ADT
Wide Rural Two-Lane Highway (Roadbed > 36 ft)	0.000742 ADT
Narrow Rural Two-Lane Highway (Roadbed < 36 ft)	0.00121 ADT
Urban Interstate	0.0009 ADT
Urban Multilane Divided Highway	0.0009 ADT
Urban Street	0.00133 ADT

Encroachment Frequency Factors

Figure 900-17

900.14 The 5/15 Rule for Location II Objects

Requests for reclassification of existing or relocated utility objects complying with all the following conditions may supersede the Engineering Analysis and Cost-Effective Selection Procedure requirements of the reclassification process.

(1) Conditions

- **Condition 1:** There are no feasible alternative measures for compliance with Control Zone Objective 2 (see [900.03](#)).
- **Condition 2:** The utility object must be located 15 feet or more from the edge of the through lane.
- **Condition 3:** The utility object must be located within 5 feet of the highway right of way line.
- **Condition 4:** The utility object must not be located within an area of concentrated utility object accidents.
- **Condition 5:** The utility object must not have a recorded accident history.

In these situations, it will be considered cost-effective for Location II Objects to remain within the highway right of way. The Engineering Analysis will consist of a utility-provided written statement that all of the above conditions are met.

Appendix B

Utility Forms and Documents

DOT Form 130-017 EF	Agreement Review Transmittal	B-2
DOT Form 224-012 EF	Blanket Bond for Franchises and Permits	B-3
DOT Form 224-030 EF	Special Provisions for Permits and Franchises, Exhibit A	B-4
DOT Form 224-035 EF	City Construction and Maintenance Permit	B-7
DOT Form 224-047 EF	Utility Installations to Existing Bridges	B-11
DOT Form 224-048 EF	Individual Bond for Franchise or Permit	B-13
DOT Form 224-051 EF	Acceptance of Assignment	B-14
DOT Form 224-053 EF	Utility Construction Agreement Work by Utility – State Cost	B-15
DOT Form 224-062 EF	Utility Construction Agreement Work by State – Utility Cost*	B-20
DOT Form 224-071 EF	Utility Construction Agreement Work by State – Shared Cost	B-26
DOT Form 224-072 EF	Utility Preliminary Agreement Work by Utility – State Cost	B-32
DOT Form 224-077 EF	Utility Construction Agreement Work by State – State Cost	B-36
DOT Form 224-096 EF	Escrow Agreement Utilities.	B-40
DOT Form 224-301 EF	Utility Preliminary Engineering Agreement Work by State – Utility Cost	B-45
DOT Form 224-696 EF	Application for Utility Permit or Franchise*	B-49
DOT Form 224-697 EF	Utility Facility Description	B-54
DOT Form 224-699 EF	Application for Utility Permit or Franchise for United States Government Agencies	B-55
DOT Form 422-004 EF	Inspector’s Daily Report	B-57
DOT Form 422-004A EF	Inspector’s Daily Report – Diary Page	B-58
DOT Form 422-014	Construction Project Diary	B-59
Authority Matrix	B-64
Blanket Crossing Agreement With USBR		B-65
Category 4 Notice of Compliance		B-93
Control Zone Variance Request Justification Questionnaire		B-94
Limited Access Encroachment and Break Justification Questionnaire		B-99
Longitudinal Median Installation Variance Request Justification Questionnaire		B-102
Notice of Filing		B-105
Open Cut Crossing Utility Trench Backfill Detail		B-106
Open Cut Pavement Request Letter		B-107
Open Cut Pavement Variance Request Justification Questionnaire		B-108
Quitclaim Deed		B-111
Roadway Prism Open Trench Variance Request Justification Questionnaire		B-115
Scenic Classification Variance Request Justification Questionnaire		B-118
Shallow Depth Installation Variance Request Justification Questionnaire		B-121
Utility Object Relocation Record		B-124
Utility Trench Backfill Detail		B-125



**Washington State
Department of Transportation**

Agreement Review Transmittal

Agreement Number	Task	Amendment	Region	Agreement Manager	Org. Code
Agreement Review Type		Form No.	HQ Agreement Reviewer		Received in HQ
Agreement Retention <input type="checkbox"/> Six (6) years <input type="checkbox"/> Twenty-Five (25) years <input type="checkbox"/> Seventy-Five (75) years					Completed Date
<input type="checkbox"/> Chapter 39.34 RCW applies.					Start Date
Payor/Payee Name and Address					Date Executed
					End Date
					Project Title
Project Description			Project Location		
			SR _____		
			MP _____ To _____		
			Control Section		
			Work Order Number		
			Fed Aid Project Number		
Agreement Budget					
Amount Payable by WSDOT		Allowed Overrun Percent %	<input type="checkbox"/> Reportable Under Performance Based Contracting Policy		
Amount Reimbursable to WSDOT		Advance Payment Amount			
Notes to HQ (Specify Accounting / Reviewer)					
HQ Agreement Review Comments					
Initiated By			Date	Phone	

DOT Form 130-017 Revised 06/2011

Agreement Review Transmittal DOT Form 130-017 EF



Blanket Bond for Franchises and Permits

Bond No. _____

KNOW ALL MEN BY THESE PRESENTS: That we, _____ of _____ County _____ as Principal, and _____ as Surety, are jointly and severally bound unto the STATE OF WASHINGTON in the sum of \$10,000 DOLLARS, for payment of which to the State of Washington, we jointly and severally bind ourselves, our heirs, executors, administrators, and assigns, firmly by these presents.

WHEREAS, the Principal in pursuance of its operations has filed with the Washington State Department of Transportation, under the provisions of Chapter 47.50 RCW and/or Chapter 47.32 RCW and/or Chapter 47.44 RCW and amendments thereto, applications for various permits and franchises and will file applications for additional permits and franchises to construct, operate, and maintain its facilities along, under, and across various highways under jurisdiction of the Washington State Department of Transportation.

NOW, THEREFORE, the condition of this obligation is such that if all the conditions of said permits and franchises, including the proper restoration of slopes, slope treatment, topsoil, landscape treatment, drainage facilities, and cleanup of right of way, are complied with according to the terms contained in said permits and franchises by said Principal, through a period in accordance with Chapter 468.34.020 (3) WAC and upon receipt of a written discharge from the State, then this obligation shall become null and void; otherwise, this bond to remain in full force and effect.

WITNESS our hands and seals this _____ day of _____, _____.

NOTE: Please **type or print below the signatures** the names of parties executing this bond, together with official title of each.

Principal: _____

Address: _____

Telephone: _____

By: _____

Title: _____

**WASHINGTON STATE
DEPARTMENT OF TRANSPORTATION**

Surety: _____

Address: _____

Telephone: _____

By: _____

Title: _____

Date: _____

By: _____

Title: _____

DOT Form 224-012 EF
Revised 6/95

Blanket Bond for Franchises and Permits DOT Form 224-012 EF



Special Provisions for Permits and Franchises

Permit/Franchise No.

Applicable provisions are denoted by ()

- 1. No Work provided for herein shall be performed until the Utility is authorized by the Washington State Department of Transportation (Department) representative listed in section 2.
- 2. The Utility shall notify in writing the identified Department representative at least () calendar days in advance of commencing Work on state-owned highway right of way.

Department Representative:

Name: _____	Name: _____
Title: _____	Title: _____
Address: _____	Address: _____
City, State, Zip _____	City, State, Zip _____
E-mail: _____	E-mail: _____
Phone: _____ FAX: _____	Phone: _____ FAX: _____

- 3. Should the Utility choose to perform the Work outlined herein with other than its own forces, the Utility shall include in the Section 2 notification the name, address, and telephone number of its contractor.
- 4. Should the Utility choose to perform the Work outlined herein with other than its own forces, an authorized representative of the Utility shall be present or available at all times unless otherwise agreed to by the Department representative. A list of authorized representatives shall be submitted prior to the construction start date. (Authorized representatives are defined as persons having signatory authority for the Utility.)
- 5. All contact between the Department and the Utility's contractor shall be through the Utility representative. Where the Utility chooses to perform the Work with its own forces, it may elect to appoint one of its own employees engaged in the construction as its representative. Failure to comply with this provision shall be grounds for restricting any further Work by the Utility within the state-owned highway right of way until said requirement is met. The Utility, at its own expense, shall adequately police and supervise all Work performed by itself, its contractor, subcontractor, agent, and/or others, so as not to endanger or injure any person or property.
- 6. The responsibility of the Utility for proper performance, safe conduct, and adequate policing and supervision of the Work shall not be lessened or otherwise affected by the Department's approval of plans, specifications, or work, or by the Department representative's presence at the work site.
- 7. Prior to beginning the Work, the Department and the Utility shall hold a preconstruction conference with the Utility's engineer, contractor, and inspector.
- 8. If the Department has a contractor doing work in the vicinity of the Utility's Work, the Utility agrees to schedule and perform its Work in such a manner as not to delay the Department's contractor's work.
- 9. Work within the right of way shall be restricted to between the hours of _____ and _____. No work shall be allowed on the right of way Saturday, Sunday, or holidays, unless authorized by the Department. Any lane closures must be submitted for approval in advance of use. The hours of permitted closure may differ from the above noted hours.
- 10. The Utility agrees that, in the event any construction and/or maintenance of the highway facility becomes necessary within the proximity of the utility installation during the time the Utility will be working within the highway right of way, it is expressly understood that, upon request from the Department's representative, the Utility will promptly identify and locate by suitable field markings any and all of its underground facilities so that the Department or its contractor can be fully apprised at all times of their precise locations.

Special Provisions for Permits and Franchises, Exhibit A DOT Form 224-030 EF (Page 1 of 3)

11. Construction of this facility will not be permitted from the shoulders or through the traffic lanes and/or ramps of SR _____. All construction access will be from _____.
12. All vehicles and equipment that are not essential for the Work shall not be parked on the shoulders or thru-traffic lanes and/or ramps of SR _____.

BOND AND INSURANCE COVERAGE

13. The Utility has provided bond coverage for the Work under this Permit or Franchise by furnishing a blanket surety bond held by the Department at the WSDOT Headquarters Utilities Unit in Olympia, WA.
14. The Utility shall provide a surety bond to the Department in the amount of \$ _____, written by a surety company authorized to do business in the State of Washington, or shall set up a Department-approved escrow account prior to the start of construction to cover the Work under this Permit or Franchise. The surety bond or escrow account shall remain in force for a period of one (1) year after the completion of the Work, except that when the construction impacts the traveled lanes, the Utility shall be required to maintain the surety bond or escrow account for a period of two (2) years after completion of the Work.
15. The Utility shall provide proof of insurance coverage prior to performing any Work within state-owned highway right of way, as follows:
- (a) Commercial General Liability covering the risks of bodily injury (including death), property damage, and personal injury, including coverage for contractual liability, with a limit of not less than \$1 million per occurrence/\$2 million general aggregate;
 - (b) Business Automobile Liability (owned, hired, or non-owned) covering the risks of bodily injury (including death) and property damage, including coverage for contractual liability, with a limit of not less than \$1 million per accident;
 - (c) Employers Liability covering the risks of Utility's employees' bodily injury by accident or disease, with limits of not less than \$1 million per accident for bodily injury by accident and \$1 million per employee for bodily injury by disease.

Such insurance policies or related certificates of insurance shall name the Washington State Department of Transportation as an additional insured on all general liability, automobile liability, employers' liability, and excess policies. A forty-five (45) calendar day written notice shall be given to the Department prior to termination of or any material change to the policy(ies) as such relate(s) to this Permit or Franchise.

16. If the Utility is a City, it may choose to provide verification of insurance coverage to the Department by establishing its membership in "Washington Cities Insurance Authority," or to verify that the City is self-insured, to comply with the insurance terms and conditions of this Permit or Franchise.

UNDERGROUND FACILITIES

17. For underground facilities, markers shall be placed at each right of way line at one end of a normal crossing, at both ends of an oblique crossing, and at all changes in offset distance from right of way line or centerline of the highway and placed every 500 feet for longitudinal installations. Marker information shall include owner name, pipeline or cable identification and station, and telephone number or other means to contact a local office. Markers may also include depth of cover, size, pressure and contents of carrier, and potential of ducted wires and cables. Markers must meet an industry standard that will not create a safety hazard, and all markers shall be placed and maintained so as to minimize interference with Department maintenance operations. It is the Utility's responsibility to maintain its markers. Maintenance of markers includes but is not limited to update of Utility's name (if changed) or Utility's successors' or assigns' contact information, and replacement of damaged or missing markers.
18. The Utility shall install detector tape or cable approximately 12 inches above the underground facility. The tape shall conform to the standards of the American Public Works Association Uniform Color Code.
19. The highway shoulders, where disturbed, shall be resurfaced in kind with crushed surfacing top course at _____-inch minimum compacted depth, or as directed by the Department's representative. The surface of the finished shoulder shall slope down from the edge of pavement at the rate of 5% unless otherwise directed. Any restored shoulders shall not have any sections less than 2 feet wide.

Special Provisions for Permits and Franchises, Exhibit A *DOT Form 224-030 EF (Page 2 of 3)*

20. Utility facilities or casings for facilities crossing under highways surfaced with oil, asphalt concrete pavement, or cement concrete pavement shall be by trenchless construction, using the appropriate equipment to jack, bore, or auger the facility through the highway prism with a minimum depth of 5 feet along any point from the top of facility to the lowest point of the finished highway grade, at a minimum of 3.5 feet depth from bottom of ditch to top of facility.
21. Trenchless construction shall include a component by which the utility can be located with conventional methods.
22. Casing requirements (WAC 468-34-210) for utilities are specified individually or in whole on the attached exhibits. Any variances to these casing requirements need to be justified, in writing, and approved by the Department.
23. Open trenching (cutting a trench for direct placement of a utility that does not include cutting an existing paved highway surface) will only be allowed at the locations identified on the plan sheets and/or listed on Exhibit(s) _____, with restoration to be performed as noted on the attached "Open Trench Detail," Exhibit _____.
24. Open cuts (cutting a trench for direct placement of a utility that does include cutting the existing paved highway surface) of the highway are a variance to Department policy, requiring justification (Open Cut Variance Request) and approval by the Department prior to the Work beginning. Open cuts are only allowed at approved locations identified on the plan sheets and/or listed on Exhibit(s) _____, with restoration to be performed as noted on the attached "Open Cut Detail," Exhibit _____.
25. If determined necessary by the Department representative, any or all of the excavated material shall be removed and replaced with suitable material as specified by the Department. It is the Utility's responsibility to obtain any necessary permits or comply with applicable requirements to haul or dispose of any excavated material.
26. If determined by the Washington State Department of Labor and Industries and/or the Department representative that extra Shoring (beyond that specified in Section 7-08.3(1)B of the Department's Standard Specifications for Road, Bridge, and Municipal Construction) is necessary for the safety of the workers or the protection of the highway pavement, the trenching or excavation work shall be stopped and no Work in the trench or excavation area will be allowed until satisfactory modifications are made.
27. During working hours, all open trenches shall be marked by warning signs, barricades, and flashing beacons. If necessary, flagmen shall be employed for the purpose of protecting the traveling public.
28. All trenches, boring or jacking pits, etc., shall be backfilled as soon as possible. If left open during nonworking hours, they shall be covered with material of sufficient strength to withstand traffic loads. Methods of protection shall be submitted a minimum of _____ () calendar days in advance for approval by the Department prior to use.

AERIAL/ABOVEGROUND FACILITIES

29. Neutral conductors associated with circuits of 0 to 22 Kilovolts, where the neutral is considered to be 0-750 Volts, will be required to have a minimum clearance of 24 feet as indicated in WAC 468-34-290, Vertical Clearance, provided the facility is grounded at each pole at each end of the crossing.
30. The Utility agrees to underground the aboveground facilities covered by this Franchise in Scenic Classes "A," "AX," "B," and/or "BX," as defined on the attached Exhibit(s), at the time the pole owner undergrounds its facility. The existing aboveground facility may remain or be relocated as aboveground in Scenic Classes "AX" or "BX," if acceptable to the Department.
31. The Utility agrees to underground or relocate the existing aboveground facilities covered by this Franchise in Scenic Classes "A," "AX," "B," and/or "BX," as defined on the attached Exhibit(s), to a location acceptable to the Department either at the time of reconstruction, for the portion of line to be reconstructed, or prior to the expiration of this Franchise. The existing aboveground facility may remain or be relocated as aboveground in Scenic Classes "AX" or "BX," if acceptable to the Department.

MAINTENANCE

32. No routine maintenance of the facility authorized by this Permit or Franchise will be allowed within the limited access area.
33. Maintenance of this facility will not be permitted from the shoulders, thru-traffic lanes, and/or ramps of SR _____, and all service to this facility will be accessed from _____.
34. The Utility will notify the Department representative, listed in section 2, five (5) calendar days prior to any maintenance work to be performed in the state-owned highway right of way.



City Construction and Maintenance Permit

Permit Number

Please print or type all information

Application is hereby made for Construction and Maintenance of City Utilities Located Within state-owned Limited Access Highway Right of Way Pursuant to RCW 47.52.090

The intended Use of Limited Access State-owned Right of Way is to Construct and Maintain a: _____ on a portion of State Route _____ (at/from) Mile Post _____ to Mile Post _____ in _____ County, to begin in the _____ Section _____ Township _____ North: Range _____ West/East W.M. and end in the _____ Section _____ Township _____ North: Range _____ West/East W.M.

Applicant (Referred to as City)	Applicant Authorized Signature
Address	Print or Type Name
City _____ State _____ Zip Code _____	Title
Telephone _____	Dated this _____ day of _____ Year _____
Applicant Reference (WO) Number _____	

Authorization to Construct and Maintain

The Washington State Department of Transportation, referred to as the "Department," pursuant to the provisions of RCW 47.52.090, hereby grants this Construction and Maintenance Permit subject to the terms and conditions stated in the General Provisions, Special Provisions, and Exhibits attached hereto and by this reference made a part hereof: Construction of facilities proposed under this application shall begin within one year and must be completed within three years from date of authorization.

For Department Use Only

Exhibits Attached	Department Authorization By _____ _____ Title _____ _____ Date _____ _____
-------------------	--

City Construction and Maintenance Permit
DOT Form 224-035 EF (Page 1 of 4)

General Provisions (City Construction and Maintenance Permit)

1. The City shall notify the following Department representative, in writing, at least _____ (_____) calendar days in advance of commencing Construction or Maintenance work within state-owned limited access highway right of way.
 Department Representative:
 Name _____
 Title _____
 Address _____

 City _____ State _____ Zip Code _____
 Phone Number _____
2. Upon authorization of this Construction and Maintenance Permit, the City shall diligently proceed with the work and comply with all provisions herein.
3. Prior to the beginning of construction, a preconstruction conference shall be held at which the Department, the City, and the City's contractor (if applicable) shall be present.
4. Should the City choose to perform the work outlined herein with other than its own forces, a representative of the City shall be present on-site at all times unless otherwise agreed to by the Department. All contact between the Department and the City's contractor shall be through an authorized representative of the City. Where the City chooses to perform the work with its own forces, it may elect to appoint one of its own employees engaged in the construction as its representative. Failure to comply with this provision shall be grounds for restricting any further work by the City within the state-owned limited access highway right of way until said requirement is met. The City, at its own expense, shall adequately police and supervise all work on the above-described project by itself, its contractor, subcontractor, or agent, and others, so as not to endanger or injure any person or property.
5. All City facilities occupying state-owned limited access highway right of way shall comply with applicable minimum clearance, depth, encasement and Control Zone requirements as specified in the Washington State Department of Transportation Utilities Manual M 22-87, and revisions thereto.
6. Should the City choose to perform the work outlined herein with other than its own forces, a surety bond in the amount of \$ _____ written by a surety company authorized to do business in the State of Washington, shall be furnished to the Department before performing any work to ensure compliance with all of the terms and conditions of this Construction and Maintenance Permit and shall remain in force until all work under this Construction and Maintenance Permit has been completed, and the City's contractor has restored any affected Department property and right of way to the satisfaction of the Department.
7. The City must provide proof of the following insurance coverage prior to performing any work within right of way:
 - a) Commercial General Liability covering the risks of bodily injury (including death), property damage and personal injury, including coverage for contractual liability, with a limit of not less than \$1 million per occurrence/\$2 million general aggregate;
 - b) Business Automobile Liability (owned, hired, or non-owned) covering the risks of bodily injury (including death) and property damage, including coverage for contractual liability, with a limit of not less than \$1 million per accident;
 - c) Employers Liability insurance covering the risks of City's employees' bodily injury by accident or disease with limits of not less than \$1 million per accident for bodily injury by accident and \$1 million per employee for bodily injury by disease;
 Such insurance policies or related certificates of insurance shall name the Washington State Department of Transportation as an additional insured on all general liability, automobile liability, employers' liability, and excess policies. The City may comply with these insurance requirements through a program of self insurance that meets or exceeds these minimum limits.

The City must provide the Department with adequate documentation of self insurance prior to performing any work within state-owned limited access highway right of way. Should the City no longer benefit from a program of self-insurance, the City agrees to promptly obtain insurance as provided above. A forty-five (45) Calendar Day written notice shall be given to prior to termination of or any material change to the policy(ies) as it relates to this Permit.

8. Work within the state-owned limited access highway right of way shall be restricted between the hours of _____ and _____, and no work shall be allowed on the right of way on Saturday, Sunday, or holidays as defined by RCW 1.16.050, or the day before a holiday or a holiday weekend, unless authorized by the Department.
9. All of the work shall be done to the satisfaction of the Department. All material and workmanship shall conform to the Washington State Department of Transportation's Standard Specifications for Road, Bridge, and Municipal Construction, current edition, and amendments thereto, and shall be subject to inspection by the Department. All Department inspections and acceptance of state-owned limited access right of way restoration are solely for the benefit of the Department and not for the benefit of the City, the City's contractor (if any), or any third party.
10. During the construction and/or maintenance of this facility, the City shall comply with the Manual on Uniform Traffic Control Devices for Streets and Highways (Federal Highway Administration) and the state of Washington's modifications thereto (chapter 468-95 WAC). If determined necessary by the Department, the City shall submit a signing and traffic control plan to the Department's Representative for approval prior to construction or maintenance operations. No lane closures shall be allowed except as approved by the Department's Representative. Approvals may cause revision of special provisions of this Construction and Maintenance Permit, including hours of operation.
11. No excavation shall be made or obstacle placed within the limits of the state-owned limited access highway right of way in such a manner as to interfere with the construction of, operation of, maintenance of and/or travel over the highway, unless authorized by the Department in writing.
12. If the work done under this Construction and Maintenance Permit interferes in any way with the drainage of the state highway, the City shall wholly and at its own expense make such provisions as the Department may direct to fully mitigate the drainage impacts.
13. For any of the City's work that requires permit coverage under the "CONSTRUCTION STORMWATER GENERAL PERMIT – National Pollutant Discharge Elimination System and State Waste Discharge General Permit for Stormwater Discharges Associated with Construction Activity" (hereinafter "Construction Stormwater General Permit"), the City shall obtain said permit coverage and shall comply with all requirements of the Construction Stormwater General Permit. Upon Department request, the City shall provide a copy of the Construction Stormwater General Permit. In addition, the City, on behalf of itself and its contractors, officers, officials, employees, and agents, agrees to indemnify, hold harmless, and defend at its sole cost and expense the Department, its officers, officials, employees, and agents from any and all fines, costs, claims, judgments, and/or awards of damages (to regulatory agencies, persons, and/or property), arising out of, or in any way resulting from the City's failure to (1) obtain coverage under the Construction Stormwater General Permit for utility work or (2) comply with the Construction Stormwater General Permit requirements.
14. Upon completion of the work authorized by this Construction and Maintenance Permit, all rubbish and debris shall be immediately removed and the state-owned limited access highway right of way shall be left neat and presentable to the Department's satisfaction. City agrees to take corrective action if directed by the Department.
15. If any construction or future maintenance of the facilities covered under this Construction and Maintenance Permit involves equipment or personnel crossing limited access boundaries at grade, the City shall secure an access break from the Department prior to commencement of construction or maintenance activities.
16. All facilities placed within state-owned limited access highway right of way by the City under this Construction and Maintenance Permit shall remain the property of the City and may be removed at any time by the City. Prior to removal, the City shall notify the Department and submit a plan for removal of the facilities. Additionally, in the event that all or any portion of the facilities are no longer used, the City shall submit a plan and schedule removal of the facilities. Upon removal of any facilities under this section, the City shall restore any affected Department property or state-owned limited access highway right of way to a condition satisfactory to the Department.

City Construction and Maintenance Permit
DOT Form 224-035 EF (Page 3 of 4)

17. If the Department, in its sole discretion, shall determine that any or all of the City's facilities must be modified, removed or relocated from the state-owned limited access highway right of way as being necessary, incidental, or convenient for the construction, repair, improvement, alteration, relocation, or maintenance of the state highway, or for the safety of the traveling public, the City, its successors or assigns, shall at its sole cost and expense, upon written notice by the Department, modify, relocate or remove any or all of its facilities from the state-owned limited access highway right of way as may be required by the Department. The City shall timely perform all facility modifications, relocations and/or removals as the Department directs to avoid highway project delays and in such manner as will cause the least interference with the continued operation and/or maintenance of the highway or disruption of traffic.
18. Should the City fail or refuse to comply with the Department's direction to modify, remove, or relocate any City facilities, the Department may undertake and perform the work, and the City agrees to pay the Department's reasonable cost and expense for performing the work. The Department shall provide to the City a detailed invoice for the work, and the City agrees to make payment within thirty (30) calendar days of the date of the invoice.
19. If the Department determines in good faith that emergency maintenance work to the City's facilities is immediately needed to protect (a) any aspect of the state highway, or (b) to secure the safety of the traveling public, as a result of a failure of the City's facility, such work may be performed by the Department without prior approval of the City, and the City agrees to pay the Department's reasonable cost and expense for performing the work. The City will be notified of the emergency work and the necessity for it at the Department's earliest opportunity. The Department shall provide to the City a detailed invoice for such emergency work, and the City agrees to make payment within thirty (30) calendar days of the date of the invoice.
20. The City, its successors and assigns, agree to indemnify, defend, and hold harmless the State of Washington and its officers and employees, from all claims, demands, damages (both to persons and/or property), expenses, regulatory fines, and/or suits that: (1) arise out of or are incident to any acts or omissions by the City, its agents, contractors, and/or employees, in the use of the state-owned limited access highway right of way as authorized by the terms of this Construction and Maintenance Permit, or (2) are caused by the breach of any of the conditions of this Construction and Maintenance Permit by the City, its contractors, agents, and/or employees. The City, its successors and assigns, shall not be required to indemnify, defend, or hold harmless the State of Washington and its officers and employees, if the claim, suit, or action for damages (both to persons and/or property) is caused by the acts or omissions of the State of Washington, its officers and employees; provided that, if such claims, suits, or actions result from the concurrent negligence of (a) the State of Washington, its officers and employees and (b) the City, its agents, contractors, and/or employees, or involves those actions covered by RCW 4.24.115, the indemnity provisions provided herein shall be valid and enforceable only to the extent of the acts or omissions of the State of Washington, its officers and employees and the City, its agents, contractors, and/or employees.
- 20.1. The City agrees that its obligations under this section extend to any claim, demand and/or cause of action brought by, or on behalf of, any of its employees or agents while performing construction and/or maintenance under this Construction and Maintenance Permit while located on state-owned limited access highway right of way. For this purpose, the City, by mutual negotiation, hereby waives with respect to the Department only, any immunity that would otherwise be available to it against such claims under the Industrial Insurance provisions chapter 51.12 RCW.
- 20.2. This indemnification and/or waiver shall survive the termination of this Permit.
21. Any action for damages against the State of Washington, its agents, contractors, or employees, arising out of damages to a utility or other facility located on the state-owned limited access highway right of way shall be subject to the provisions and limitations of RCW 47.44.150.
22. This Construction and Maintenance Permit shall not be deemed or held to be an exclusive one and shall not prohibit the Department from granting rights of like or other nature to other public or private utilities, nor shall it prevent the Department from using any of its highways, rights of ways, or other state-owned property, or affect its right to full supervision and control over all or any state-owned property, none of which is hereby surrendered.
23. No assignment or transfer of this Construction and Maintenance Permit in any manner whatsoever shall be valid, nor vest any rights hereby granted, until the Department consents thereto and the assignee accepts all terms of this Construction and Maintenance Permit. Attempting to assign this permit without Department consent shall be cause for cancellation as herein provided.



General Notes and Design Criteria for Utility Installations to Existing Bridges

General Notes

All materials and workmanship shall be in accordance with the requirements of the state of Washington, Department of Transportation, Standard Specifications for Road, Bridge, and Municipal Construction, current edition. The utility conduits shall be labeled in accordance with Section 6-01.10.

All steel in utility supports, including fastenings and anchorages, shall be galvanized in accordance with AASHTO M-111 or M-232 (ASTM A-123 or A-153 respectively).

All utilities and utility support surfaces, including any galvanized utilities, shall be given a primer coat of state standard formula A-6-86 and two coats of state standard formula C-9-86. The final coat shall match the bridge color.

Galvanized metal or aluminum utilities completely hidden from public view may be exempted from the above painting requirements.

Any painted surfaces damaged during construction shall be cleaned and painted as noted above.

Any paint splatters shall be removed from the bridge.

Appearance of the utility installation shall be given serious consideration in all cases. Where possible, the utility installation shall be hidden from public view.

The notes and criteria explained here are presented as a guide only. Each proposed utility installation shall be submitted to the Department of Transportation for approval on an individual basis. Compliance with these criteria does not assure approval, nor does variance from these criteria, for reasonable cause, necessarily exclude approval.

Design Criteria

1. Pipelines carrying volatile fluids through a bridge superstructure shall be designed by the utility company in accordance with WAC 480-93, Gas Companies - Safety, and Minimum Federal Safety Standard, Title 49 Code of Federal Regulations (CFR) Section part 192. WAC 468-34-210, Pipelines - Encasement, describes when casing is required for carrying volatile fluids across structures. Generally, casing is not required for pipelines conveying natural gas per the requirements of WAC 468-34-210. If casing is required, then WAC 468-34-210 and WAC 480-93-115 shall be followed.
2. Utilities shall not be attached above the bridge deck nor attached to railing or rail posts.
3. Utilities shall not extend below bottom of superstructure.

DOT Form 224-047 EF
Revised 5/10

Exhibit " _____ " _____
Permit/Franchise _____
Page _____ of _____

Utility Installations to Existing Bridges
DOT Form 224-047 EF (Page 1 of 2)

- 4. The utilities shall be provided with suitable expansion devices near bridge expansion joints and/or other locations as required to prevent temperature and other longitudinal forces from being transferred to bridge members.
- 5. Rigid conduit shall extend 10 feet (3 meters) minimum, beyond the end of the bridge abutment.
- 6. Utility supports shall be designed such that neither the conduit, the supports, nor the bridge members are overstressed by any loads imposed by the utility installation.
- 7. Utility locations and supports shall be designed so that a failure (rupture, etc.) will not result in damage to the bridge, the surrounding area, or be a hazard to traffic.
- 8. Conduit shall be rigid.

(Items 1 through 8 may be cross-referenced with Bridge Design Manual, Utilities Section.)

- 9. Lag screws may be used for attaching brackets to wooden structures. All bolt holes shall meet the requirements of Sections 6-04.3(4) and 6-04.3(5) of the Washington State Department of Transportation Standard Specifications for Road, Bridge, and Municipal Construction, current edition.
- 10. Welding across main members will not be permitted. All welding must be approved.
- 11. Utilities shall be located to minimize bridge maintenance and bridge inspection problems.
- 12. Attach conduits or brackets to the concrete superstructure with resin bond anchors. Lag screws shall not be used for attachment to concrete.
- 13. Drilling through reinforcing steel will not be permitted. If steel is hit when drilling, the anchorage location must be moved and the abandoned hole filled with nonshrink grout conforming to the requirements of Section 9-20.3(2) and placement shall be as required in Section 6-02.3(20) of the Washington State Department of Transportation Standard Specifications for Road, Bridge, and Municipal Construction, current edition.
- 14. There shall be a minimum of 3 inches (80 millimeters) edge distance to the center line of bolt holes in concrete.
- 15. All utilities and utility supports shall be designed not only to support their dead load but to resist other forces from the utility (surge, etc.) and wind and earthquake forces. The utility company may be asked to submit one set of calculations to verify their design forces.
- 16. Drilling into prestressed concrete members for utility attachments shall not be allowed.
- 17. Water or sewer lines to be placed lower than adjacent bridge footings shall be encased if failure can cause undermining of the footing.

DOT Form 224-047 EF
Revised 5/10

Exhibit " _____ "

Permit/Franchise _____

Page _____ of _____

Utility Installations to Existing Bridges
DOT Form 224-047 EF (Page 2 of 2)



Individual Bond for Franchise and Permit

Bond No. _____

KNOW ALL MEN BY THESE PRESENTS: That we, _____ of _____ County _____ as Principal, and _____ as Surety, are jointly and severally bound unto the STATE OF WASHINGTON in the sum of _____ DOLLARS, for payment of which to the State of Washington, we jointly and severally bind ourselves, our heirs, executors, administrators, and assigns, firmly by these presents.

WHEREAS, the Principal in pursuance of its operations has filed with the Washington State Department of Transportation, under the provisions of Chapter 47.50 RCW and/or Chapter 47.32 RCW and/or Chapter 47.44 RCW and amendments thereto, applications for franchise/permit number _____ on a portion of State Route No. _____ in _____ County, Washington.

NOW, THEREFORE, the condition of this obligation is such that if all the conditions of said franchise/permit, including the proper restoration of slopes, slope treatment, topsoil, landscape treatment, drainage facilities, and cleanup of right of way, are complied with according to the terms contained in said franchise/permit by said Principal, through a period in accordance with Chapter 468.34.020 (3) WAC and upon receipt of a written discharge from the State, then this obligation shall become null and void; otherwise, this bond to remain in full force and effect.

WITNESS our hands and seals this _____ day of _____, _____.

NOTE: Please type or print below the signatures the names of parties executing this bond, together with official title of each.

Principal: _____

Address: _____

Telephone: _____

By: _____

Title: _____

Surety: _____

Address: _____

Telephone: _____

By: _____

Title: _____

Date: _____

By: _____

Title: _____

DOT Form 224-048 EF
Revised 6/95

Individual Bond for Franchise or Permit DOT Form 224-048 EF



Acceptance of Assignment (Transfer of Ownership)

_____ (Assignor) hereby assigns
to _____ (Assignee) effective
_____, Permit(s) and/or Franchise Number(s):
_____ (date)

The Assignee hereby takes and accepts the aforesaid Permit(s) and/or Franchise(s) granted by, or on behalf of, the Washington State Department of Transportation and agrees to keep, perform, and observe the terms and conditions of said Permit(s) and/or Franchise(s).

NOTE: Please **print or type** the names and official titles of the persons signing and authorized to bind each of the Parties.

Assignor Signature: _____

Name (print): _____

By: _____

Title: _____

Date: _____

Assignee Signature: _____

Name (print): _____

By: _____

Title: _____

Date: _____

Accepted by WSDOT this _____ day of _____, _____.

**Washington State
Department of Transportation**

By: _____

Title: _____

DOT Form 224-051 EF
Revised 06/2012

Acceptance of Assignment
DOT Form 224-051 EF



Application for Utility Permit or Franchise for United States Government Agencies

Permit/Franchise No.

Applicant - Please print or type all information

Application is Hereby Made For: Permit Category 1
 Franchise Amendment Category 2
 Franchise Consolidation Category 3
 Franchise Renewal

Intended Use of State Right of Way is to Construct, Operate, and Maintain a:

_____ on a portion of
 State Route _____ (at/from) MilePost _____ to Mile Post _____ in _____ County,
 to begin in the _____ Section _____ Township _____ North: Range _____ West/East W.M.
 and end in the _____ Section _____ Township _____ North: Range _____ West/East W.M.

The Applicant agrees to reimburse the Department for additional costs incurred that are beyond the basic administrative expense incident to the processing of this application in accordance with WAC 468-34 and RCW 47.44 and amendments.

Applicant (Referred to as Utility)	Applicant Authorized Signature
Address	Print or Type Name
City _____ State _____ Zip Code _____	Title _____
Telephone _____	Dated this _____ day of _____, _____
Applicant Reference (WO) Number _____	Federal Tax ID Number or Social Security Number _____

Authorization to Occupy Only If Approved Below

The Washington State Department of Transportation referred to as the "Department," hereby grants this document (Permit or Franchise as applicable) subject to the terms and conditions stated in the General Provisions, Special Provisions, and Exhibits attached hereto and by this reference made a part hereof. Construction facilities proposed under this application shall begin within one year and must be completed within three years from date of approval.

For Department Use Only

Exhibits Attached	<p>Department Approval</p> <p>By: _____</p> <p>_____</p> <p>Title: _____</p> <p>Date: _____</p> <p>Expiration Date: _____</p>
-------------------	--

DOT Form 224-699 EF
Revised 1/2010

Utility Construction Agreement Work by Utility – State Cost
 DOT Form 224-053 EF (Page 1 of 5)

- 1.4 The UTILITY shall furnish the labor, materials, equipment, and tools required for and perform the Work in constructing, removing and/or relocating the UTILITY facilities, in accordance with Exhibit A, Special Provisions, and Exhibit C, Plans.
- 1.5 If the UTILITY is not adequately staffed or equipped to perform all the Work required herein, the UTILITY may have all or part of this Work done by a contract let by the UTILITY, as follows:
- 1.5.1 Before contracting out any Work, the UTILITY shall obtain written authorization from the STATE, and the STATE may require the UTILITY to advertise and solicit bids for the contract Work.
- 1.5.2 If the STATE requires the Work to be advertised and bid, the UTILITY shall provide a copy of all bid documents to the STATE seven (7) calendar days prior to the advertisement date, or as specified in Exhibit A, for STATE comment.
- 1.5.3 The UTILITY shall notify the STATE at least three (3) working days in advance of the location and time of the bid opening so that a STATE representative may attend the bid opening.
- 1.5.4 The UTILITY shall supply a copy of the three lowest bids with itemized bid amounts to the STATE within seven (7) calendar days of bid opening
- 1.5.5 If the UTILITY elects to use other than the lowest bid contractor, the UTILITY shall provide written justification to the STATE for the use of that contractor and bid price. The STATE shall review the UTILITY's written justification, and if the STATE does not agree therewith and the UTILITY awards the bid to other than the lowest bid contractor, the UTILITY shall be responsible for the cost difference between the amount of the lowest bid and the amount of the awarded contract.
- 1.6 If the UTILITY desires to have the Work performed under an existing contract, the STATE may require the UTILITY to provide the STATE with a copy of the contract for the STATE's written approval of the contractor and contract charges.
- 1.7 The Parties agree that nothing in the STATE's approval of a UTILITY contractor or bid shall be for the benefit of the UTILITY; all such approvals, whether written or verbal, shall be solely for the benefit of the STATE and shall not establish a contractual relationship among the STATE, the UTILITY, and the UTILITY's contractor.
- 1.8 All of the UTILITY's Work, construction procedures, materials, and/or utility installation, as provided under this Agreement, shall be subject to STATE inspection for solely the benefit of the STATE's payment, state highway and/or STATE project. The UTILITY shall promptly notify the STATE in writing when the Work is completed. The STATE shall inspect the Work for compliance with the Exhibits attached to this Agreement. The STATE will notify the UTILITY in writing of any non-compliance that would impact the STATE's payment, state highway and/or STATE project. The UTILITY agrees to make the necessary changes to satisfy the STATE requirements or adjust the invoice. The STATE's inspection shall not reduce or modify the UTILITY's responsibility for the Work.
- 1.9 Upon completion of the Work, the UTILITY agrees that it shall be solely responsible for all future ownership, operation and maintenance costs of its facilities, without STATE liability or expense.

2. AUTHORITY TO BEGIN WORK AND WORK SCHEDULE

- 2.1 The UTILITY agrees not to begin Work until the STATE has provided written notice, authorizing the UTILITY to begin Work. The STATE shall not be obligated to reimburse the UTILITY for any Work performed before the date of notification.
- 2.2 The UTILITY agrees to schedule and perform the Work in such manner as not to delay or interfere with the STATE's contractor in the performance of the STATE's project. The UTILITY shall be responsible for any costs resulting from delay of, or interference with, the STATE's project contractor, to the extent the delay or interference is attributable to the UTILITY or the UTILITY's contractor. Any mutually agreed conditions or requirements for avoidance of delay of, or interference with, the STATE's project contractor shall be included in Exhibit A.

3. COMPLIANCE

- 3.1 The UTILITY agrees to comply with all applicable requirements of the STATE in accordance with the Utilities Accommodation Policy, Chapter 468-34 WAC, and amendments thereto, and said policy and amendments are hereby incorporated in and made a part of this Agreement for all intents and purposes as if fully set forth herein.
- 3.2 The UTILITY agrees to comply with all applicable laws and environmental requirements of any jurisdictional agency and is responsible for obtaining any necessary environmental permits required in order to perform the Work.
- 3.3 The UTILITY agrees to obtain and comply with any other permits from any jurisdictional agency that are required in order for the UTILITY to perform the Work.

4. PAYMENT

- 4.1 The STATE is responsible for the cost of the Work, excluding all betterment work, for the UTILITY's facilities that are located pursuant to a documented ownership interest in real property, such as an easement, fee title, or court finding of prescriptive right, which are impacted by the STATE project, as shown in Exhibits A and B. Exhibit B, Cost Estimate, contains an itemized cost estimate of STATE-responsible costs for the Work to be performed by the UTILITY.
- 4.2 The STATE, in consideration of the faithful performance of the Work to be done by the UTILITY, agrees to reimburse the UTILITY for the actual direct and related indirect cost of the Work, excluding all betterment work, for which the STATE is responsible as defined in Exhibits A and B. The UTILITY agrees to invoice the STATE and provide supporting documentation for all charges, and the STATE agrees to pay the UTILITY within thirty (30) days of receipt of an invoice. Payments shall not be more frequent than one per month. A partial payment will not constitute agreement as to the appropriateness of any item and that, at the time of final invoice, the Parties will resolve any discrepancies.
- 4.3 The UTILITY shall submit a final invoice to the STATE within ninety (90) calendar days following completion of the Work. In the event that the final invoice reveals an overpayment to the UTILITY, the UTILITY agrees to refund such overpayment to the STATE within thirty (30) days.

5. CHANGE IN WORK OR COST INCREASE

- 5.1 The STATE agrees that the amount shown in Exhibit B may not reflect the actual costs of the Work. Should the UTILITY determine that the Work costs for which the STATE is responsible might exceed the cost estimate by more than _____ (____) percent, the UTILITY shall immediately notify the STATE before performing any Work in excess of the Exhibit B estimate plus the additional percentage. The STATE and the UTILITY will, if necessary, amend Exhibit B to revise the cost estimate before the UTILITY incurs costs above the amount shown in Exhibit B plus the additional percentage.
- 5.2 Should it be necessary to modify Exhibit A, Special Provisions, the UTILITY agrees to immediately notify the STATE of all proposed changes, and the STATE agrees to provide written notice of its acceptance or rejection of the change(s), in writing, within _____ (____) working days.

6. FRANCHISE, PERMIT OR EASEMENT

- 6.1 The UTILITY shall apply for a permit, franchise or an amendment to its current franchise for those new or modified UTILITY facilities that will be located within the STATE's right of way. After receiving the application, the STATE will issue the UTILITY a permit or a new or amended franchise.
- 6.2 Upon completion of the Work covered under this Agreement, the UTILITY agrees to prepare, execute and deliver to the STATE a quit claim deed for all existing easements, fee title, or court finding of prescriptive right, which will be vacated as a result of the relocation of UTILITY facilities and as identified in Exhibit A.
- 6.3 In exchange for the quit claim deed, the STATE agrees to grant or issue the UTILITY an easement, permit, or franchise, as defined in Exhibit A, for those UTILITY facilities which will remain on or which cross the STATE's right-of-way and for which the UTILITY had an easement, fee title or court finding of prescriptive right. A legal description of and use conditions for an easement to be granted encumbering STATE right of way shall be included in Exhibit A.

7. RIGHT OF ENTRY

- 7.1 Subject to the UTILITY obtaining all required permits and meeting any other requirements for Work conducted within state-owned right of way, the STATE hereby grants the UTILITY a right of entry upon all land in which the STATE has interest for the purpose of performing the Work. Upon completion of the Work, this right of entry shall terminate except as otherwise provided in Section 6.
- 7.2 A STATE grant of access and right of entry onto an interstate limited access right of way may require additional conditions, for example, a traffic control plan will be required if the UTILITY's Work will impact highway traffic. The Parties agree that all UTILITY access and right of entry provisions affecting an interstate limited access right of way will be identified in Exhibit A, Special Provisions. Upon completion of the Work, this right of entry shall terminate except as otherwise provided in Section 6.
- 7.3 The UTILITY shall not enter state-owned right of way without first having a STATE-issued written right of entry.

8. GENERAL PROVISIONS

- 8.1 **Indemnification:** To the extent authorized by law, the UTILITY and STATE shall indemnify and hold harmless one another and their employees and/or officers from and shall process and defend at its own expense any and all claims, demands, suits at law or equity, actions, penalties, losses, damages (both to persons and/or property), or costs, of whatsoever kind or nature, brought against the one Party arising out of, in connection with, or incident to the other Party's performance or failure to perform any aspect of this Agreement, provided, however, that if such claims are caused by or result from the concurrent negligence of (a) the UTILITY and (b) the STATE, their respective employees and/or officers, or involves those actions covered by RCW 4.24.115, this indemnity provision shall be valid and enforceable only to the extent of the negligence of the UTILITY or STATE, and provided further, that nothing herein shall require the UTILITY or STATE to hold harmless or defend the other or its employees and/or officers from any claims arising from that Party's sole negligence or that of its employees and/or officers. The terms of this section shall survive the termination of this Agreement.
- 8.2 **Disputes:** If a dispute occurs between the UTILITY and the STATE at any time during the prosecution of the Work, the Parties agree to negotiate at the management level to resolve any issues. Should such negotiations fail to produce a satisfactory resolution, the Parties agree to enter into arbitration and/or mediation before proceeding to any other legal remedy. Each Party shall be responsible for its own fees and costs. The Parties agree to equally share the cost of a mediator or arbiter.
- 8.3 **Venue:** In the event that either Party deems it necessary to institute legal action or proceedings to enforce any right or obligation under this Agreement, the Parties hereto agree that any such action or proceedings shall be brought in the superior court situated in Thurston County, Washington. Each Party shall be responsible for its own attorney's fees and costs.
- 8.4 **Termination:**
- 8.4.1 The UTILITY understands that the STATE retains the right to terminate this Agreement for convenience upon thirty (30) calendar days written notice to the UTILITY. In the event that the STATE exercises this termination right, the STATE will reimburse the UTILITY for all allowable costs under this Agreement incurred prior to the date of termination.
- 8.4.2 In the event funding for the Work is withdrawn, reduced, or limited in any way after the execution date of this Agreement and prior to normal completion, the STATE may terminate the Agreement upon less than the thirty (30) calendar day notice requirement in section 8.4.1, subject to renegotiation at STATE's sole option pursuant to the revised funding limitations and conditions.
- 8.5 **Amendments:** This Agreement may be amended by the mutual agreement of the Parties. Such amendments or modifications shall not be binding unless put in writing and signed by persons authorized to bind each of the Parties.

- 8.6 Independent Contractor: Both Parties shall be deemed independent contractors for all purposes, and the employees of each Party and any of its contractors, subcontractors, consultants, and the employees thereof, shall not in any manner be deemed to be the employees of the other Party.
- 8.7 Audit and Records: During the progress of the Work and for a period of not less than three (3) years from the date of final payment. The UTILITY shall maintain the records and accounts pertaining to the Work and shall make them available during normal business hours and as often as necessary, for inspection and audit by the STATE, State of Washington, and/or Federal Government and copies of all records, accounts, documents or other data pertaining to the Work will be furnished upon request. The requesting Party shall pay the cost of copies produced. If any litigation, claim or audit is commenced, the records and accounts along with supporting documentation shall be retained until any litigation, claim or audit finding has been resolved even though such litigation, claim or audit continues past the three-year retention period.
- 8.9 Working Days: Working days for this Agreement are defined as Monday through Friday, excluding Washington State holidays per RCW 1.16.050.

IN WITNESS WHEREOF, the Parties hereto have executed this Agreement as of the day and year last written below.

UTILITY

**STATE OF WASHINGTON
DEPARTMENT OF TRANSPORTATION**

By _____

By _____

Name _____

Name _____

Title _____

Title _____

Date _____

Date _____

Utility Construction Agreement Work by Utility – State Cost
DOT Form 224-053 EF (Page 5 of 5)



Utility Construction Agreement Work by State - Utility Cost		Utility Name and Address
Agreement Number	Region	Project Title / Location
State Route	Mileposts From To	
Estimated Agreement Amount \$		Advance Payment Amount <input type="checkbox"/> N/A \$

This Utility Construction Agreement is made and entered into between the State of Washington Department of Transportation, herein (STATE) and the above named UTILITY.

WHEREAS, the STATE is planning the construction or improvement of the State Route as shown above for the listed STATE Project, and in connection therewith, it is necessary to remove and/or relocate and/or construct certain UTILITY facilities, herein the (Work), and

WHEREAS, the UTILITY is responsible for (1) the cost of the Work for UTILITY facilities located without a documented ownership of and/or interest in real property, such as being located pursuant to a franchise, a permit, or undocumented permission, (2) all betterments, and (3) new facilities, and

WHEREAS, the Work shall be defined as all materials, equipment, labor, contract administration and any other efforts required to perform the relocation, construction, and/or removal of the UTILITY's facilities, and

WHEREAS, the Work includes Betterments; Relocation of Facilities with Property Rights; Facilities without Property Rights; Installation of New Facilities; Removal of Existing Facilities from the STATE right of way, and

WHEREAS, it is deemed to be in the best public interest for the STATE to include the Work in the STATE's Project,

NOW, THEREFORE, pursuant to RCW 47.01.210 and chapter 47.44 RCW and in consideration of the terms, conditions, covenants, and performances contained herein, as well as the attached Exhibits which are incorporated and made a part hereof,

IT IS MUTUALLY AGREED AS FOLLOWS:

1. PLANS, SPECIFICATIONS AND BIDS

- 1.1 Program Guide: *Utility Relocation and Accommodation on Federal Aid Highway Projects* shall determine and establish the definitions and applicable standards and payments for this Agreement. By this reference this document is adopted and made a part of this Agreement as if fully contained herein.
- 1.2 Betterment: A betterment is any improvement to the UTILITY's facilities not required by code, regulation, standard industry practice, or any other applicable regulation. If any of the Work constitutes a betterment as defined in the Program Guide: *Utility Relocation and Accommodation on Federal Aid Highway Projects*, the UTILITY is solely responsible for the costs of such improvement.
- 1.3 The STATE, acting on behalf of the UTILITY, agrees to perform the UTILITY facilities Work in accordance with Exhibit A, Special Provisions, and Exhibit C, Plans, where either: (1) UTILITY supplied the Work plans and special provisions to the STATE, or (2) STATE developed the Work plans and special provisions from UTILITY-provided information.

The STATE will incorporate the Plans and Special Provisions into the STATE Project in accordance with UTILITY requirements. The UTILITY agrees that it is solely responsible for insuring that all Special Provisions, Plans and UTILITY standards are met and that it has supplied the STATE with all applicable standards, codes, regulations, or any other requirements the UTILITY is obligated to meet, unless otherwise noted.

- 1.4 The UTILITY has reviewed and approved the Work Special Provisions and Plans that will be incorporated into the STATE Project. The STATE will advertise the Work and Project for bids. The STATE will be the UTILITY's representative during the Ad and award period. When requested by the STATE, the UTILITY shall timely assist the STATE in answering bid questions and resolving any design issues that may arise associated with the Work. All comments and clarifications must go through the STATE. If the UTILITY supplied the Work plans and special provisions, the UTILITY agrees to provide the STATE with any addenda required for the Work during the Ad period, to the Parties' mutual satisfaction.
- 1.5 The STATE will provide the UTILITY with written notification of the bid price no later than five (5) days after award for all Work items for which the UTILITY is responsible for the cost. The UTILITY shall respond in writing to the STATE, stating its Acceptance or Rejection of the Work items, within two (2) working days.
- 1.6 Should the UTILITY reject the bid Work items for which it has cost responsibility:
- 1.6.1 The STATE shall delete said items from the Project. The UTILITY agrees to reimburse the STATE for engineering costs and direct and related indirect costs incurred by the STATE associated with deleting the bid Work items from the Project, including any redesign, reengineering or re-estimating, if necessary, to delete the Work items, and the UTILITY agrees to pay such costs upon receipt of a STATE invoice.
- 1.6.2 The UTILITY agrees that should it reject the bid Work items for which it has cost responsibility, it shall continue to be obligated to timely relocate its facilities as required by the STATE Project. The UTILITY further agrees that should its actions delay or otherwise damage the STATE Project, it shall be liable for such costs.

2. CONSTRUCTION, INSPECTION, AND ACCEPTANCE

- 2.1 The STATE agrees to administer the Work on behalf of the UTILITY.
- 2.2 The UTILITY agrees to disconnect and/or reconnect its facilities as required by the STATE when such disconnection or reconnection is required to be performed by the UTILITY. The Parties agree to define disconnect and/or reconnection requirements, including notification and response in Exhibit A. The STATE agrees, as part of the Work, to remove disconnected and/or abandoned facilities at the UTILITY's cost. UTILITY facilities not removed pursuant to this Agreement shall remain the ownership, operation and maintenance responsibility of the UTILITY.
- 2.3 Salvage: All materials removed by the STATE shall be reclaimed or disposed of by the STATE and shall become the property of the STATE. If the UTILITY desires to retain such materials and the STATE agrees, the value of salvaged materials will be paid to the STATE in an amount not less than that required by the Program Guide: *Utility Relocation and Accommodation on Federal Aid Highway Projects*.
- 2.4 The UTILITY may furnish an inspector for the Work. The UTILITY agrees that it is solely responsible for all such inspection costs. The UTILITY's inspector shall not directly contact the STATE's contractor. All contact between the UTILITY's inspector and the STATE's contractor shall be through the STATE's representatives. The STATE's Project Construction Engineer may require the removal and/or replacement of the UTILITY's inspector if the inspector interferes with the STATE's Project, STATE's contractor and/or the Work.
- OR**
- 2.4 The UTILITY shall furnish an inspector for the Work. The UTILITY agrees that it is solely responsible for all such inspection costs. The UTILITY's inspector shall not directly contact the STATE's contractor. All contact between the UTILITY's inspector and the STATE's contractor shall be through the STATE's representatives. The STATE's Project Construction Engineer may require the removal and/or replacement of the UTILITY's inspector if the inspector interferes with the STATE's Project, STATE's contractor and/or the Work.

Utility Construction Agreement Work by State – Utility Cost DOT Form 224-062 EF (Page 2 of 6)

- 2.5 The STATE shall promptly notify the UTILITY in writing when the Work is completed.
- 2.6 The UTILITY shall, within _____(_____) working days of being notified that the Work is completed: (a) deliver a letter of acceptance to the STATE which shall include a release and waiver of all future claims or demands of any nature resulting from the performance of the Work and the STATE's administration thereof, or (b) deliver to the STATE written reasons why the Work does not comply with the previously approved Plans and Special Provisions.
- The UTILITY agrees to work diligently and in good faith with the STATE to resolve any issues so as not to delay the STATE's Project. If all issues are resolved, the UTILITY agrees to deliver to the STATE a letter of acceptance as provided herein.
- 2.7 If the UTILITY does not respond within _____(_____) working days as provided in Section 2.6, the Work and the administration thereof will be deemed accepted by the UTILITY, and the STATE shall be released from all future claims and demands.
- 2.8 Upon completion and acceptance of the Work pursuant to Sections 2.6 or 2.7, the UTILITY agrees that it shall be solely responsible for all future ownership, operation and maintenance costs of its facilities, without STATE liability or expense.
- 2.9 The STATE will prepare the final construction documentation in general conformance with the STATE's Construction Manual. The STATE will maintain one set of plans as the official "as-built" set, then make notations in red of all plan revisions typically recorded per standard STATE practice, as directed by the STATE's Construction Manual. Once the UTILITY has accepted the Work per Section 2.6 or 2.7, the STATE upon request by the UTILITY will provide one reproducible set of contract as-builts to the UTILITY, and the UTILITY agrees to pay the cost of reproduction upon receipt of a STATE invoice

3. PAYMENT

- 3.1 The UTILITY agrees that it shall be responsible for the actual direct and related indirect costs, including mobilization, construction engineering, contract administration and overhead costs, associated with the Work. The cost of this Work is estimated to be _____ Dollars (\$ _____). An itemized estimate of UTILITY-responsible costs for Work to be performed by the STATE on behalf of the UTILITY is included in Exhibit B, Cost Estimate.
- 3.2 When applicable the UTILITY agrees to pay the STATE the "Advance Payment Amount" stated above within twenty (20) calendar days after the STATE submits its first partial payment request to the UTILITY. The advance payment represents fifteen (15) percent of the estimate of cost for which the UTILITY is responsible. The advance payment will be carried throughout the life of the Work with final adjustment made in the final invoice
- 3.3 The Parties acknowledge and agree that the STATE does not have the legal authority to advance state funds for the UTILITY's Work under this Agreement. Should the UTILITY fail to make payment according to the terms of this Agreement, the STATE shall have the right to terminate this Agreement, charging the UTILITY for all associated costs of termination, including non-cancellable items, as well as associated Project delay and contractor claims. Such termination shall not relieve the UTILITY's obligation to timely relocate its facilities as provided under Section 1.6.2
- 3.4 The UTILITY, in consideration of the faithful performance of the Work to be done by the STATE, agrees to pay the STATE for the actual direct and related indirect cost of all Work for which the UTILITY is responsible, including mobilization, construction engineering, administration and overhead costs. The STATE shall invoice the UTILITY and provide supporting documentation therefore, and the UTILITY agrees to pay the STATE within thirty (30) calendar days of receipt of an invoice. A partial payment will not constitute agreement as to the appropriateness of any item and that, at the time of final invoice, the Parties will resolve any discrepancies.

4. CHANGE IN WORK OR COST INCREASE

- 4.1 Increase in Cost: In the event unforeseen conditions require an increase in the cost of the Work for which the UTILITY is responsible, above the Exhibit B, Cost Estimate (including sales tax, engineering, and contingencies) by more than _____ (_____) percent, the Parties agree to modify Exhibit B to include such cost increase.
- 4.2 If the STATE determines that additional Work or a change in the Work is required, prior written approval must be secured from the UTILITY; however, where the change is required to mitigate a Project emergency or safety threat to the traveling public, the STATE will direct the change without the UTILITY's prior approval. The STATE will notify the UTILITY of such change as soon as possible thereafter. The UTILITY agrees to respond to all STATE change order requests in writing and within five (5) working days. STATE notification shall not be required for UTILITY-requested changes. The UTILITY agrees to pay all costs associated with the changed Work, as well as the costs of Project or Work delays and/or subsequent contractor claims associated with the UTILITY's failure to timely respond as required.
- 4.3 The UTILITY may request additions to the Work through the STATE in writing. The STATE will implement the requested changes as elective changes, provided that a change does not negatively impact the STATE's transportation system and complies with the Standard Specifications, Project permits, state and/or federal law, applicable rules and/or regulations, and/or STATE design policies, and does not unreasonably delay critically scheduled Project contract activities.
- 4.4 All elective changes to the Work shall be approved in writing by the UTILITY before the STATE directs the contractor to implement the changes, even if an executed change order is not required by the Project contract. The UTILITY agrees to pay for the increases in cost, if any, for such elective changes in accordance with Section 3.
- 4.5 The STATE will make available to the UTILITY all change order documentation related to the Work.

5. FRANCHISE OR PERMIT

- 5.1 The UTILITY shall apply for a permit, franchise or an amendment to its current franchise for those new or modified UTILITY facilities that will be located within the STATE's right of way. After receiving the application, the STATE will issue the UTILITY a permit or a new or amended franchise.

6. RIGHT OF ENTRY

- 6.1 The UTILITY agrees to arrange for rights of entry upon all privately owned lands upon which the UTILITY has a claimed property right and which are necessary to perform the Work. The UTILITY also agrees to obtain all necessary permissions for the STATE to perform the Work on such lands, which may include reasonable use restrictions on those lands. The UTILITY agrees to provide the rights of entry and applicable permissions under this section to the STATE within _____ (_____) calendar days of entering into this Agreement. Upon completion of the Work on such lands, the rights of entry and permissions shall terminate.

7. GENERAL PROVISIONS

- 7.1 Indemnification: To the extent authorized by law, the UTILITY and STATE shall indemnify and hold harmless one another and their employees and/or officers from and shall process and defend at its own expense any and all claims, demands, suits at law or equity, actions, penalties, losses, damages (both to persons and/or property), or costs, of whatsoever kind or nature, brought against the one Party arising out of, in connection with, or incident to the other Party's performance or failure to perform any aspect of this Agreement, provided, however, that if such claims are caused by or result from the concurrent negligence of (a) the UTILITY and (b) the STATE, their respective employees and/or officers, or involves those actions covered by RCW 4.24.115, this indemnity provision shall be valid and enforceable only to the extent of the negligence of the UTILITY or STATE, and provided further, that nothing herein shall require the UTILITY or STATE to hold harmless or defend the other or its employees and/or officers from any claims arising from that Party's sole negligence or that of its employees and/or officers. The terms of this section shall survive the termination of this Agreement.

- 7.2 **Disputes:** If a dispute occurs between the UTILITY and the STATE at any time during the prosecution of the Work, the Parties agree to negotiate at the management level to resolve any issues. Should such negotiations fail to produce a satisfactory resolution, the Parties agree to enter into arbitration and/or mediation before proceeding to any other legal remedy. Each Party shall be responsible for its own fees and costs. The Parties agree to equally share the cost of a mediator or arbiter.
- 7.3 **Venue:** In the event that either Party deems it necessary to institute legal action or proceedings to enforce any right or obligation under this Agreement, the Parties hereto agree that any such action or proceedings shall be brought in the superior court situated in Thurston County, Washington. Each Party shall be responsible for its own attorney's fees and costs.
- 7.4 **Termination:**
- 7.4.1 Unless otherwise provided herein, the UTILITY may terminate this Agreement upon thirty (30) calendar days written notice to the STATE. If this Agreement is terminated by the UTILITY prior to the fulfillment of the terms stated herein, the UTILITY shall reimburse the STATE for all actual direct and related indirect expenses and costs, including mobilization, construction engineering, contract administration and overhead costs, incurred up to the date of termination associated with the UTILITY Work, as well as the cost of non-cancelable obligations, including any redesign, reengineering or re-estimating, if necessary, to delete the Work, and contractor claims, if any, payment in accordance with Section 3. Further, the UTILITY acknowledges and agrees that should it terminate this Agreement, such termination shall not relieve the UTILITY from its responsibility to design, remove, relocate and/or construct its facilities so as not to delay or conflict with the STATE's Project. The STATE agrees to provide to the UTILITY all Work-related documents upon final payment by the UTILITY.
- 7.4.2 Unless otherwise provided herein, the STATE may terminate this Agreement upon thirty (30) calendar days written notice to the UTILITY. Should the STATE terminate this Agreement, the UTILITY shall reimburse the STATE for all actual direct and related indirect expenses and costs, including mobilization, construction engineering, contract administration and overhead costs, incurred by the STATE up to the date of termination associated with the UTILITY Work. The UTILITY acknowledges and agrees that should the STATE terminate this Agreement, such termination shall not relieve the UTILITY from its responsibility to design, remove, relocate and/or construct its facilities so as not to delay or conflict with the STATE's Project. The STATE agrees to provide to the UTILITY all Work-related documents upon final payment by the UTILITY.
- 7.5 **Amendments:** This Agreement may be amended by the mutual agreement of the Parties. Such amendments or modifications shall not be binding unless put in writing and signed by persons authorized to bind each of the Parties.
- 7.6 **Independent Contractor:** Both Parties shall be deemed independent contractors for all purposes, and the employees of each Party and any of its contractors, subcontractors, consultants, and the employees thereof, shall not in any manner be deemed to be the employees of the other Party.
- 7.7 **Audit and Records:** During the progress of the Work and for a period of not less than three (3) years from the date of final payment, both Parties shall maintain the records and accounts pertaining to the Work and shall make them available during normal business hours and as often as necessary, for inspection and audit by the other Party, State of Washington, and/or Federal Government and copies of all records, accounts, documents or other data pertaining to the Work will be furnished upon request. The requesting Party shall pay the cost of copies produced. If any litigation, claim or audit is commenced, the records and accounts along with supporting documentation shall be retained until any litigation, claim or audit finding has been resolved even though such litigation, claim or audit continues past the three-year retention period.
- 7.8 **Working Days:** Working days for this Agreement are defined as Monday through Friday, excluding Washington State holidays per RCW 1.16.050.

IN WITNESS WHEREOF, the Parties hereto have executed this Agreement as of the day and year last written below.

UTILITY

**STATE OF WASHINGTON
DEPARTMENT OF TRANSPORTATION**

By _____

By _____

Name _____

Name _____

Title _____

Title _____

Date _____

Date _____

Utility Construction Agreement Work by State – Utility Cost
DOT Form 224-062 EF (Page 6 of 6)



<p align="center">Utility Preliminary Engineering Agreement Work by Utility - State Cost</p>			Utility Name and Address
			Project Title / Location
Agreement Number	Region		
Control Section	State Route	Mileposts From To	
Estimated Agreement Amount			

This Utility Preliminary Engineering Agreement, herein "Agreement," is made and entered into between the State of Washington, Department of Transportation, herein "STATE," and the above named Utility, herein "UTILITY."

WHEREAS, the STATE is planning the construction or improvement of the State Route as shown above for the listed STATE project, and in connection therewith, it is necessary to remove, relocate or construct certain UTILITY facilities, and

WHEREAS, the STATE is responsible for the cost of the preliminary engineering for the UTILITY's facilities that are located pursuant to a documented ownership interest in real property, such as an easement, fee title, or court finding of prescriptive right, which is impacted by the STATE project, but the STATE is not responsible for preliminary engineering costs associated with facility betterments, and

WHEREAS, it is deemed to be in the best public interest for the UTILITY to develop the preliminary engineering, including the preparation of plans, specifications and cost estimate, herein the "Work," for the removal, relocation or construction of the UTILITY's facilities as part of the STATE's project, and

WHEREAS, the STATE and the UTILITY intend to enter into a Utility Construction Agreement to cover the actual construction, relocation, and/or removal of the UTILITY's facilities,

NOW, THEREFORE, pursuant to chapter RCW 47.10.210 and chapter 47.44 RCW, and in consideration of the terms, conditions, covenants, and performances contained herein, as well as the attached Exhibits which are incorporated and made a part hereof,

IT IS MUTUALLY AGREED AS FOLLOWS:

1. PLANS, SPECIFICATIONS AND BIDS

- 1.1 Program Guide: *Utility Relocation and Accommodation on Federal Aid Highway Projects* shall determine and establish the definitions and applicable standards and payments under this Agreement. By this reference this document is adopted and made a part of this Agreement as if fully contained herein.
- 1.2 Betterment: A betterment is any improvement to the UTILITY's facilities not required by code, regulation, standard industry practice, or any other applicable regulation. If any of the Work constitutes a betterment as defined in the Program Guide: *Utility Relocation and Accommodation on Federal Aid Highway Projects*, the UTILITY is solely responsible for the preliminary engineering costs of such improvement.
- 1.3 The UTILITY agrees to perform the preliminary engineering, including the preparation of plans, specifications and cost estimates (PS&E), herein the "Work," for the removal, relocation, and/or construction of the UTILITY's facilities impacted by the STATE's project. Should the Work include betterments to the facilities, the UTILITY shall identify such betterments for STATE review. The STATE has provided to the UTILITY a copy of the STATE's project plans, identified as Exhibit C.

- 1.4 The UTILITY agrees to provide the STATE a copy of its PS&E, including the identification of betterments, if any. The STATE will review for acceptance of the PS&E to ensure that it is in compliance with STATE requirements and standards prior to incorporating it into the STATE project plans. The Parties agree to comply with the document submission and review process as identified in Exhibit A, Special Provisions, including the Scope of Work.
- 1.5 If the UTILITY is not adequately staffed or equipped to perform all of the Work required herein, the UTILITY may have all or part of the Work performed by consultant(s) under a contract let by the UTILITY or have the Work performed under an ongoing contract with a UTILITY consultant. UTILITY consultant(s) shall be in good standing with the STATE, and the UTILITY shall provide to the STATE for STATE review a cost estimate for the Work to be performed by the UTILITY's consultant(s).

2. PAYMENT

- 2.1 The STATE is responsible for the cost of the Work, excluding all betterment work, for the UTILITY's facilities that are located pursuant to a documented ownership interest in real property, such as an easement, fee title, or court finding of prescriptive right, which are impacted by the STATE project, as shown in Exhibits A and B. Exhibit B, Cost Estimate, contains an itemized cost estimate of STATE-responsible costs for the Work to be performed by the UTILITY.
- 2.2 The STATE, in consideration of the faithful performance of the Work to be done by the UTILITY, agrees to reimburse the UTILITY for the actual direct and related indirect cost of the Work, excluding all betterment work, for which the STATE is responsible as defined in Exhibits A and B. The UTILITY agrees to invoice the STATE and provide supporting documentation for all charges, and the STATE agrees to pay the UTILITY within thirty (30) calendar days of receipt of an invoice. Payments shall not be more frequent than one per month. A partial payment will not constitute agreement as to the appropriateness of any item and that, at the time of final invoice, the Parties will resolve any discrepancies.
- 2.3 The UTILITY shall submit a final billing to the STATE within ninety (90) calendar days following completion of the Work.

3. CHANGE IN WORK OR COST INCREASE

- 3.1 Increase in Cost: In the event unforeseen conditions require an increase in the cost of the Work for which the STATE is responsible, the Exhibit B, Cost Estimate (including sales tax, engineering, and contingencies) by more than _____ (_____) percent, the Parties agree to modify Exhibit B to include such cost increase.
- 3.2 Should it be necessary to modify the Scope of Work, the UTILITY agrees to immediately notify the STATE of all proposed changes, and the STATE agrees to provide written notice of its acceptance or rejection of the change(s), in writing, within _____ (_____) working days.

4. RIGHT OF ENTRY

- 4.1 The STATE hereby grants to the UTILITY a right of entry onto all lands in which it has an interest for the Work as defined in Exhibits A and C. Upon completion and acceptance of the Work, this right of entry shall terminate, except as otherwise provided in Section 5.4.
- 4.2 The UTILITY agrees to obtain rights of entry, if needed, upon all privately owned lands necessary to perform the Work. The UTILITY also agrees to obtain all necessary permissions for the STATE to enter upon such lands, if required, for the duration of this Agreement. The UTILITY agrees to provide the rights of entry and applicable permissions to the STATE within _____ (_____) calendar days of entering into this Agreement. Upon completion of the Work on such lands, the rights of entry and permissions shall terminate, except as otherwise provided in Section 5.4.

5. GENERAL PROVISIONS

- 5.1 **Indemnification:** The UTILITY shall indemnify and hold harmless the STATE and its agents, employees, and/or officers from and shall process and defend at its own expense any and all claims, demands, suits at law or equity, actions, penalties, losses, damages (both to persons and/or property), or costs, of whatsoever kind or nature, brought against the STATE and its agents, employees and/or officers, arising out of, in connection with, or incident to the Work performed by the UTILITY pursuant to the terms of this Agreement. Provided, however, that if such claims are caused by or result from the concurrent negligence of (a) the UTILITY and (b) the STATE, its agents, employees, and/or officers, or involves those actions covered by RCW 4.24.115, this indemnity provision shall be valid and enforceable only to the extent of the intentional or negligent acts or omissions of the UTILITY; Provided further, that nothing herein shall require the UTILITY to hold harmless or defend the STATE, its agents, employees, and/or officers from any claims arising from the sole negligence of the STATE, its agents, employees, and/or officers. This indemnification shall survive any termination of this Agreement.
- 5.2 **Disputes:** If a dispute occurs between the UTILITY and the STATE at any time during the performance of the Work pursuant to this Agreement, the Parties agree to negotiate at the management level to resolve any issues. Should such negotiations fail to produce a satisfactory resolution, the Parties agree to enter into arbitration and/or mediation before proceeding to any other legal remedy. Each Party shall be responsible for its own fees and costs. The Parties agree to equally share in the cost of a mediator or arbitrator.
- 5.3 **Venue:** In the event that either Party to this Agreement deems it necessary to institute legal action or proceedings to enforce any right or obligation under this Agreement, the Parties agree that any such action or proceedings shall be brought in the superior court situated in Thurston County, Washington. Further, the Parties agree that each shall be responsible for its own attorneys fees and costs.
- 5.4 **Termination:** Neither the STATE nor the UTILITY may terminate this Agreement without the concurrence of the other Party. Termination shall be in writing and signed by both Parties.
- 5.5 **Amendments:** This Agreement may be amended by the mutual agreement of the Parties. Such amendments or modifications shall not be binding unless put in writing and signed by persons authorized to bind each of the Parties.
- 5.6 **Independent Contractor:** Both Parties shall be deemed independent contractors for all purposes, and the employees of each Party and any of its contractors, subcontractors, consultants, and the employees thereof, shall not in any manner be deemed to be the employees of the other Party.
- 5.7 **Audit and Records:** During the progress of the Work and for a period of not less than three (3) years from the date of final payment, the UTILITY shall maintain the records and accounts pertaining to the Work and shall make them available during normal business hours and as often as necessary, for inspection and audit by the State of Washington and/or Federal Government and copies of all records, accounts, documents or other data pertaining to the Work will be furnished upon request. The requesting Party shall pay the cost of copies produced. If any litigation, claim or audit is commenced, the records and accounts along with supporting documentation shall be retained until any litigation, claim or audit finding has been resolved even though such litigation, claim or audit continues past the three-year retention period.
- 5.8 **Working Days:** Working days for this Agreement are defined as Monday through Friday, excluding Washington State holidays per RCW 1.16.050.

IN WITNESS WHEREOF, the Parties hereto have executed this Agreement as of the day and year last written below.

UTILITY

**STATE OF WASHINGTON
DEPARTMENT OF TRANSPORTATION**

By _____

By _____

Name _____

Name _____

Title _____

Title _____

Date _____

Date _____

Utility Preliminary Agreement Work by Utility – State Cost
DOT Form 224-072 EF (Page 4 of 4)



Utility Construction Agreement Work by State - Shared Cost			Utility Name and Address		
			Agreement Number		Region
Control Section	State Route	Mileposts From To			
Estimated Agreement Amount		Advance Payment Amount	State Share Amount		Utility Share Amount
			%		%

This Utility Construction Agreement is made and entered into between the State of Washington Department of Transportation (STATE) and the above named UTILITY.

WHEREAS, the STATE is planning the construction or improvement of the State Route as shown above for the identified STATE Project, and in connection therewith, it is necessary to remove and/or relocate and/or construct certain UTILITY facilities (Work), and

WHEREAS, the STATE is responsible for the cost of the Work affecting the UTILITY's facilities located pursuant to a documented ownership of and/or interest in real property, such as an easement, fee title, or court finding of prescriptive right, which is impacted by the STATE Project, and

WHEREAS, the Work shall be defined as all materials, equipment, labor, contract administration and any other effort required to perform the relocation, construction, and/or removal of the UTILITY's facilities, and

WHEREAS, the Work includes Betterments; Relocation of Facilities with Property Rights; Facilities without Property Rights; Installation of New Facilities; Removal of Existing Facilities from the STATE right of way, and

WHEREAS, the UTILITY is responsible for (1) the cost of the Work for UTILITY facilities located without a documented ownership of and/or interest in real property, such as being located pursuant to a franchise, a permit, or undocumented permission, (2) all betterments, and (3) new facilities, and

WHEREAS, it is deemed to be in the best public interest for the STATE to include the Work in the STATE's Project,

NOW, THEREFORE, pursuant to RCW 47.10.210 and chapter 47.44 RCW and in consideration of the terms, conditions, covenants, and performances contained herein, as well as the attached Exhibits which are incorporated and made a part hereof,

IT IS MUTUALLY AGREED AS FOLLOWS:

1. PLANS, SPECIFICATIONS AND BIDS

- 1.1 Program Guide: *Utility Relocation and Accommodation on Federal Aid Highway Projects* shall determine and establish the definitions and applicable standards and payments under this Agreement. By this reference this document is adopted and made a part of this Agreement as if fully contained herein.
- 1.2 Betterment: A betterment is any improvement to the UTILITY's facilities not required by code, regulation, standard industry practice, or any other applicable regulation. If any of the Work constitutes a betterment as defined in the Program Guide: *Utility Relocation and Accommodation on Federal Aid Highway Projects*, the UTILITY is solely responsible for the costs of such improvement.

- 1.3 Accrued Depreciation: Accrued depreciation may be applied to any of the UTILITY's major facilities, such as a building, pump station, power plant, etc. Accrued depreciation shall not apply to the UTILITY's primary facilities, such as pipelines, conductors, poles, cable, conduit, etc. If any UTILITY facility does qualify for an adjustment due to accrued depreciation as defined in Program Guide: *Utility Relocation and Accommodation on Federal Aid Highway Projects*, the costs are calculated according to the formula in the Program Guide and the result is shown as a UTILITY cost in Exhibit B Cost Estimate.
- 1.4 The STATE, acting on behalf of the UTILITY, agrees to perform the UTILITY facilities Work in accordance with Exhibit A, Special Provisions, and Exhibit C, Plans, where either: (1) UTILITY supplied the Work plans and special provisions to the STATE, or (2) STATE developed the Work plans and special provisions from UTILITY-provided information. The STATE has incorporated the Plans and Special Provisions into the STATE Project in accordance with UTILITY requirements. The UTILITY agrees that it is solely responsible for insuring that all Special Provisions, Plans and UTILITY standards are met and that it has supplied the STATE with all applicable standards, codes, regulations, or any other requirements the UTILITY is obligated to meet, unless otherwise noted.
- 1.5 The UTILITY has reviewed and approved the Work Special Provisions and Plans that have been incorporated into the STATE Project. The STATE will advertise the Work and Project for bids. The STATE will be the UTILITY's representative during the Ad and award period. When requested by the STATE, the UTILITY shall timely assist the STATE in answering bid questions and resolving any design issues that may arise that are associated with the Work. All comments and clarifications must go through the STATE. If the UTILITY supplied the Work plans and special provisions, the UTILITY agrees to provide the STATE with any addenda required for the Work during the Ad period, to the Parties' mutual satisfaction.
- 1.6 The STATE will provide the UTILITY with written notification of the bid price on the day of bid opening for all Work items for which the UTILITY is responsible for the cost. The UTILITY shall respond in writing to the STATE, stating its Acceptance or Rejection of the Work items, within two (2) working days.
- 1.7 Should the UTILITY reject the bid Work items for which it has cost responsibility:
- 1.7.1 The STATE shall delete said items from the Project. The UTILITY agrees to reimburse the STATE for engineering costs and direct and related indirect costs incurred by the STATE associated with deleting the bid Work items from the Project, including any redesign, reengineering or re-estimating, if necessary, to delete the Work items, and the UTILITY agrees to pay such costs upon receipt of a STATE invoice.
- 1.7.2 The UTILITY agrees that should it reject the bid Work items for which it has cost responsibility, it shall continue to be obligated to timely relocate its facilities as required by the STATE Project. The UTILITY further agrees that should its actions delay or otherwise damage the STATE Project, it shall be liable for such costs.

2. CONSTRUCTION, INSPECTION, AND ACCEPTANCE

- 2.1 The STATE agrees to administer the Work on behalf of the UTILITY.
- 2.2 The UTILITY agrees to disconnect and/or reconnect its facilities as required by the STATE when such disconnection or reconnection is required to be performed by the UTILITY. The Parties agree to define disconnect and/or reconnection requirements, including notification and response in Exhibit A. The STATE agrees, as part of the Work, to remove disconnected and/or abandoned facilities at the cost of either the STATE or UTILITY, whichever is responsible for such costs. UTILITY facilities not removed pursuant to this Agreement shall remain the ownership, operation and maintenance responsibility of the UTILITY.
- 2.3 Salvage: All materials removed by the STATE shall be reclaimed or disposed of by the STATE and shall become the property of the STATE. If the UTILITY desires to retain such materials and the STATE agrees, the value of salvaged materials will be paid to the STATE in an amount not less than that required by the Program Guide: *Utility Relocation and Accommodation on Federal Aid Highway Projects*.

Utility Construction Agreement Work by State – Shared Cost DOT Form 224-071 EF (Page 2 of 6)

- 2.4 The UTILITY may furnish an inspector for the Work. The UTILITY agrees that it is solely responsible for all such inspection costs. The UTILITY's inspector shall not directly contact the STATE's contractor. All contact between the UTILITY's inspector and the STATE's contractor shall be through the STATE's representatives. The STATE's Project Construction Engineer may require the removal and/or replacement of the UTILITY's inspector if the inspector interferes with the STATE's Project, STATE's contractor and/or the Work.
- 2.5 The STATE shall promptly notify the UTILITY in writing when the Work is completed.
- 2.6 The UTILITY shall, within _____ (____) working days of being notified that the Work is completed: (a) deliver a letter of acceptance to the STATE which shall include a release and waiver of all future claims or demands of any nature resulting from the performance of the Work and the STATE's administration thereof, or (b) deliver to the STATE written reasons why the Work does not comply with the previously approved Plans and Special Provisions.
- 2.7 If the UTILITY does not respond within _____ (____) working days as provided in section 2.6, the Work and the STATE's administration thereof will be deemed accepted by the UTILITY, and the STATE shall be released from all future claims and demands.
- 2.8 Upon completion and acceptance of the Work pursuant to Sections 2.6 or 2.7, the UTILITY agrees that it shall be solely responsible for all future ownership, operation and maintenance costs of its facilities, without STATE liability or expense.
- 2.9 The STATE will prepare the final construction documentation in general conformance with the STATE's Construction Manual. The STATE will maintain one set of plans as the official "as-built" set, then make notations in red of all plan revisions typically recorded per standard STATE practice, as directed by the STATE's Construction Manual. Once the UTILITY has accepted the Work per Section 2.6 or 2.7, the STATE upon request by the UTILITY will provide one reproducible set of contract as-builts to the UTILITY, and the UTILITY agrees to pay the cost of reproduction upon receipt of a STATE invoice.

3. PAYMENT

- 3.1 The UTILITY agrees that it shall be responsible for the actual direct and related indirect costs, including mobilization, construction engineering, contract administration and overhead costs, associated with the Work for (1) new UTILITY facilities, (2) betterments, and/or (3) Work where the UTILITY does not have a documented ownership of and/or interest in real property, such as an easement, fee title, or a court finding of prescriptive right for its facilities. The cost of this Work is estimated to be _____ Dollars (\$ _____). An itemized estimate of UTILITY-responsible costs for Work to be performed by the STATE on behalf of the UTILITY is included in Exhibit B, Cost Estimate.
- 3.2 The STATE agrees that it shall be responsible for all Work costs where the UTILITY does have a documented ownership of and/or interest in real property, such as an easement, fee title, or a court finding of prescriptive right for its facilities. Exhibit B contains an itemized estimate of STATE-responsible costs for Work to be performed by the STATE on behalf of the UTILITY.
- 3.3 The UTILITY agrees to pay the STATE the "Advance Payment Amount" stated above within twenty (20) days after the STATE submits its first partial payment request to the UTILITY. The advance payment represents fifteen (15) percent of the estimate of cost for which the UTILITY is responsible. The advance payment will be carried throughout the life of the Work with final adjustment made in the final invoice.
- 3.4 The Parties acknowledge and agree that the STATE does not have the legal authority to advance state funds for the UTILITY's cost portion of the Work under this Agreement. Should the UTILITY fail to make payment according to the terms of this Agreement, the STATE shall have the right to terminate this Agreement, charging the UTILITY for all associated costs of termination, including non-cancellable items, as well as associated Project delay and contractor claims. Such termination shall not relieve the UTILITY's obligation to timely relocate its facilities as provided under section 1.7.2

- 3.5 The UTILITY, in consideration of the faithful performance of the Work to be done by the STATE, agrees to pay the STATE for the actual direct and related indirect cost of all Work for which the UTILITY is responsible, including mobilization, construction engineering, contract administration and overhead costs. The STATE shall invoice the UTILITY and provide supporting documentation therefore, and the UTILITY agrees to pay the STATE within thirty (30) calendar days of receipt of an invoice. A partial payment will not constitute agreement as to the appropriateness of any item and that, at the time of final payment, the Parties will resolve any discrepancies.

4. CHANGE IN WORK OR COST INCREASE

- 4.1 Increase in Cost: In the event unforeseen conditions require an increase in the cost of the Work for which the UTILITY is responsible, above the Exhibit B, Cost Estimate (including sales tax, engineering, and contingencies) by more than _____ (_____) percent, the Parties agree to modify Exhibit B to include such cost increase.
- 4.2 If the STATE determines that additional Work or a change in the Work is required, prior written approval must be secured from the UTILITY; however, where the change is required to mitigate a Project emergency or safety threat to the traveling public, the STATE will direct the the change without the UTILITY's prior approval. The STATE will notify the UTILITY of such change as soon as possible thereafter. The UTILITY agrees to respond to all STATE change order requests in writing and within the time limits identified in Exhibit A. The UTILITY agrees to pay all change order Work costs for which it is responsible, as well as the costs of Project or Work delays and/or subsequent contractor claims associated with the UTILITY's failure to timely respond as required.
- 4.3 The UTILITY may request additions to the Work through the STATE in writing. The STATE will implement the requested changes as elective changes, provided that a change does not negatively impact the STATE's transportation system and complies with the Standard Specifications, Project permits, state and/or federal law, applicable rules and/or regulations, and/or STATE design policies, and does not unreasonably delay critically scheduled Project contract activities.
- 4.4 All elective changes to the Work shall be approved in writing by the UTILITY before the STATE directs the contractor to implement the changes, even if an executed change order is not required by the Project contract. The UTILITY agrees to pay for the increases in cost, if any, for such elective changes in accordance with Section 3.
- 4.5 The STATE will make available to the UTILITY all change order documentation related to the Work.

5. FRANCHISE, PERMIT OR EASEMENT

- 5.1 Upon completion of the Work covered under this Agreement, the UTILITY agrees to prepare, execute and deliver to the STATE a quit claim deed for all existing easements, fee title, or court finding of prescriptive right, which will be vacated as a result of the relocation of UTILITY facilities.
- 5.2 In exchange for the quit claim deed, the STATE agrees to grant or issue the UTILITY an easement, permit, or franchise, as defined in Exhibit A, for those UTILITY facilities which will remain on or which cross the STATE's right-of-way and for which the UTILITY had an easement, fee title or court finding of prescriptive right. A legal description of and use conditions for an easement to be granted encumbering STATE right of way shall be included in Exhibit A.
- 5.3 The UTILITY shall apply for a permit, franchise or an amendment to its current franchise or permit for those new or modified UTILITY facilities that will be located within the STATE's right of way. After receiving the application, the STATE will issue the UTILITY a permit or a new or amended franchise.

6. RIGHT OF ENTRY

- 6.1 The UTILITY hereby grants to the STATE a right of entry onto all lands in which it has an interest for construction of the Work as defined in Exhibits A and C. Upon completion and acceptance of the Work, this right of entry shall terminate, except as otherwise provided in Section 5.

- 6.2 The UTILITY agrees to arrange for rights of entry upon all privately owned lands upon which the UTILITY has an easement, documented property interest, or permit that are necessary to perform the Work. The UTILITY also agrees to obtain all necessary permissions for the STATE to perform the Work on such lands, which may include reasonable use restrictions on those lands. The UTILITY agrees to provide the rights of entry and applicable permissions to the STATE within _____ (____) calendar days of entering into this Agreement. Upon completion of the Work on such lands, the rights of entry and permissions shall terminate, except as otherwise provided in Section 5.

7. GENERAL PROVISIONS

- 7.1 Indemnification: To the extent authorized by law, the UTILITY and STATE shall indemnify and hold harmless one another and their employees and/or officers from and shall process and defend at its own expense any and all claims, demands, suits at law or equity, actions, penalties, losses, damages (both to persons and/or property), or costs, of whatsoever kind or nature, brought against the one Party arising out of, in connection with, or incident to the other Party's performance or failure to perform any aspect of this Agreement; provided however, that if such claims are caused by or result from the concurrent negligence of (a) the UTILITY and (b) the STATE, their employees, and/or officers, or involves those actions covered by RCW 4.24.115, this indemnity provision shall be valid and enforceable only to the extent of the negligence of the UTILITY or STATE, and provided further, that nothing herein shall require the UTILITY or STATE to hold harmless or defend the other or its employees and/or officers from any claims arising from that Party's sole negligence or that of its employees and/or officers. The terms of this section shall survive the termination of this Agreement.
- 7.2 Disputes: If a dispute occurs between the UTILITY and the STATE at any time during the performance of the Work, the Parties agree to negotiate at the management level to resolve any issues. Should such negotiations fail to produce a satisfactory resolution, the Parties agree to enter into arbitration and/or mediation before proceeding to any other legal remedy. Each Party shall be responsible for its own fees and costs. The Parties agree to equally share in the cost of a mediator or arbiter.
- 7.3 Venue: In the event that either Party deems it necessary to institute legal action or proceedings to enforce any right or obligation under this Agreement, the Parties hereto agree that any such action or proceedings shall be brought in the superior court situated in Thurston County, Washington. Further, the Parties agree that each shall be responsible for its own attorneys fees and costs.
- 7.4 Termination: Neither the STATE nor the UTILITY may terminate this Agreement without the concurrence of the other Party, except as otherwise provided herein. Should the UTILITY terminate this Agreement prior to the fulfillment of the terms stated herein, the UTILITY agrees to reimburse the STATE for all actual direct and related indirect expenses and costs, including mobilization, construction engineering, contract administration and overhead costs, incurred up to the date of termination, as well as the cost of non-cancelable obligations, work order close out costs, and documentation finalization costs, Project delays, and contractor claims associated with the UTILITY's Agreement termination. Payments shall be made pursuant to the provisions of Section 3.
- 7.5 Amendments: This Agreement may be amended by the mutual agreement of the Parties. Such amendments or modifications shall not be binding unless put in writing and signed by persons authorized to bind each of the Parties.
- 7.6 Independent Contractor: Both Parties shall be deemed independent contractors for all purposes, and the employees of each Party and any of its contractors, subcontractors, consultants, and the employees thereof, shall not in any manner be deemed to be the employees of the other Party.
- 7.7 Audit and Records: During the progress of the Work and for a period of not less than three (3) years from the date of final payment, both Parties shall maintain the records and accounts pertaining to the Work and shall make them available during normal business hours and as often as necessary, for inspection and audit by the other Party, State of Washington, and/or Federal Government and copies of all records, accounts, documents or other data pertaining to the Work will be furnished upon request. The requesting Party shall pay the cost of copies produced. If any litigation, claim or audit is commenced, the records and accounts along with supporting documentation shall be retained until any litigation, claim or audit finding has been resolved even though such litigation, claim or audit continues past the three-year retention period.

7.8 Working Days: Working days for this Agreement are defined as Monday through Friday, excluding Washington State holidays per RCW 1.16.050

IN WITNESS WHEREOF, the Parties hereto have executed this Agreement as of the day and year last written below.

UTILITY

**STATE OF WASHINGTON
DEPARTMENT OF TRANSPORTATION**

By _____

By _____

Name _____

Name _____

Title _____

Title _____

Date _____

Date _____

Utility Construction Agreement Work by State – Shared Cost
DOT Form 224-071 EF (Page 6 of 6)



Utility Construction Agreement Work by State – State Cost		Utility Name and Address
Agreement Number	Region	Project Title / Location
State Route	Mileposts From To	
Estimated Agreement Amount \$		

This Utility Construction Agreement is made and entered into between the State of Washington Department of Transportation, herein (STATE) and the above named UTILITY.

WHEREAS, the STATE is planning the construction or improvement of the State Route as shown above for the identified STATE Project, and in connection therewith, it is necessary to remove and/or relocate and/or construct certain UTILITY facilities (Work), and

WHEREAS, the STATE is responsible for all Work under this Agreement because the UTILITY's facilities are located pursuant to a documented ownership of and/or interest in real property, such as an easement, fee title, or court finding of prescriptive right, which is impacted by the STATE Project, and

WHEREAS, the Work shall be defined as all materials, equipment, labor, contract administration and any other efforts required to perform the relocation, construction, and/or removal of the UTILITY's facilities, and

WHEREAS, it is deemed to be in the best public interest for the STATE to include the Work in the STATE's Project,

NOW, THEREFORE, pursuant to chapter 47.44 RCW and in consideration of the terms, conditions, covenants, and performances contained herein, as well as the attached Exhibits which are incorporated and made a part hereof,

IT IS MUTUALLY AGREED AS FOLLOWS:

1. PLANS, SPECIFICATIONS AND BIDS

- 1.1 Program Guide: Utility Relocation and Accommodation on Federal Aid Highway Projects shall determine and establish the definitions and applicable standards and payments for this Agreement. By this reference this document is adopted and made a part of this Agreement as if fully contained herein.
- 1.2 The STATE, acting on behalf of the UTILITY, agrees to perform the UTILITY facilities Work in accordance with Exhibit A, Special Provisions, and Exhibit C, Plans, where either: (1) UTILITY supplied the Work plans and special provisions to the STATE, or (2) STATE developed the Work plans and special provisions from UTILITY-provided information. The STATE will incorporate the Plans and Special Provisions into the STATE Project in accordance with UTILITY requirements. The UTILITY agrees that it is solely responsible for insuring that all Special Provisions, Plans and UTILITY standards are met and that it has supplied the STATE with all applicable standards, codes, regulations, or any other requirements the UTILITY is obligated to meet, unless otherwise noted.
- 1.3 The UTILITY has reviewed and approved the Work Special Provisions and Plans that will be incorporated into the STATE Project. The STATE will advertise the Work and Project for bids. The STATE will be the UTILITY's representative during the Ad and award period. When requested by the STATE, the UTILITY shall timely assist the STATE in answering bid

questions and resolving any design issues that may arise associated with the Work. All comments and clarifications must go through the STATE. If the UTILITY supplied the Work plans and special provisions, the UTILITY agrees to provide the STATE with any addenda required for the Work during the Ad period, to the Parties' mutual satisfaction.

2. CONSTRUCTION, INSPECTION, AND ACCEPTANCE

- 2.1 The STATE agrees to administer the Work on behalf of the UTILITY.
- 2.2 The UTILITY agrees to disconnect and/or reconnect its facilities as required by the STATE when such disconnection or reconnection is required to be performed by the UTILITY. The Parties agree to define disconnect and/or reconnection requirements, including notification and response in Exhibit A.
- 2.3 Salvage: All materials removed by the STATE shall be reclaimed or disposed of by the STATE and shall become the property of the STATE. If the UTILITY desires to retain such materials and the STATE agrees, the value of salvaged materials will be paid to the STATE in an amount not less than that required by the Program Guide: *Utility Relocation and Accommodation on Federal Aid Highway Projects*.
- 2.4 The UTILITY may furnish an inspector for the Work. The STATE agrees that it is responsible for all such inspection costs. The UTILITY's inspector shall not directly contact the STATE's contractor. All contact between the UTILITY's inspector and the STATE's contractor shall be through the STATE's representatives. The STATE's Project Construction Engineer may require the removal and/or replacement of the UTILITY's inspector if the inspector interferes with the STATE's Project, STATE's contractor and/or the Work.
- 2.5 The STATE shall promptly notify the UTILITY in writing when the Work is completed.
- 2.6 The UTILITY shall, within _____ (_____) working days of being notified that the Work is completed: (a) deliver a letter of acceptance to the STATE which shall include a release and waiver of all future claims or demands of any nature resulting from the performance of the Work and the STATE's administration thereof, or (b) deliver to the STATE written reasons why the Work does not comply with the previously approved Plans and Special Provisions. The UTILITY agrees to work diligently and in good faith with the STATE to resolve any issues so as not to delay the STATE's Project. If all issues are resolved, the UTILITY agrees to deliver to the STATE a letter of acceptance as provided herein.
- 2.7 If the UTILITY does not respond within _____ (_____) working days as provided in section 2.6, the Work and the administration thereof will be deemed accepted by the UTILITY, and the STATE shall be released from all future claims and demands.
- 2.8 Upon completion and acceptance of the Work pursuant to Sections 2.6 or 2.7, the UTILITY agrees that it shall be solely responsible for all future ownership, operation and maintenance costs of its facilities, without STATE liability or expense.
- 2.9 The STATE will prepare the final construction documentation in general conformance with the STATE's Construction Manual. The STATE will maintain one set of plans as the official "as-built" set, then make notations in red of all plan revisions typically recorded per standard STATE practice, as directed by the STATE's Construction Manual. Once the UTILITY has accepted the Work per Section 2.6 or 2.7, the STATE upon request by the UTILITY will provide one reproducible set of contract as-builts to the UTILITY, and the UTILITY agrees to pay the cost of reproduction upon receipt of a STATE invoice.

3. PAYMENT

- 3.1 The STATE agrees that it shall be responsible for the actual direct and related indirect costs, including mobilization, construction engineering, contract administration and overhead costs, associated with the Work. The cost of this Work is estimated to be _____ Dollars (\$ _____). An itemized estimate of STATE-responsible costs for Work to be performed by the STATE on behalf of the UTILITY is included in Exhibit B, Cost Estimate.

- 3.2 If the UTILITY chooses to have an inspector for the Work, the UTILITY will provide a detailed estimate of such costs to be included in Exhibit B. The UTILITY agrees to provide a detailed invoice to the STATE for UTILITY inspector costs in accordance with the estimate included in Exhibit B, and the STATE agrees to make payment within thirty (30) calendar days of receipt of the invoice.
- 3.3 Pursuant to Section 4, if additional Work or a change in the Work is required and UTILITY review is necessary, the UTILITY agrees to provide a detailed invoice to the STATE, and the STATE agrees to make payment for all reasonable costs within thirty (30) calendar days of receipt of the invoice.

4. CHANGE IN WORK

- 4.1 If the STATE determines that additional Work or a change in the Work is required, prior written approval must be secured from the UTILITY; however, where the change is required to mitigate a Project emergency or safety threat to the traveling public, the STATE will direct the change without the UTILITY's prior approval. The STATE will notify the UTILITY of such change as soon as possible thereafter. The UTILITY agrees to respond to all STATE change order requests in writing and within five (5) working days.
- 4.2 The STATE will make available to the UTILITY all change order documentation related to the Work.

5. FRANCHISE OR PERMIT

- 5.1 Upon completion of the Work covered under this Agreement, the UTILITY agrees to prepare, execute and deliver to the STATE a quit claim deed for all existing easements which will be vacated as a result of the relocation of UTILITY facilities.
- 5.2 In exchange for the quit claim deed, the STATE agrees to grant or issue the UTILITY an easement, permit, or franchise, as defined in Exhibit A, for those UTILITY facilities which will remain on or which cross the STATE's right-of-way and for which the UTILITY had an easement, fee title, or court finding of prescriptive right. A legal description of and use conditions for an easement to be granted encumbering STATE right of way shall be included in Exhibit A.

6. RIGHT OF ENTRY

- 6.1 The UTILITY hereby grants to the STATE a right of entry onto all lands in which it has an interest for construction of the Work as defined in Exhibits A and C. Upon completion and acceptance of the Work, this right of entry shall terminate, except as otherwise provided in Section 5.
- 6.2 The UTILITY agrees to arrange for rights of entry upon all privately owned lands upon which the UTILITY has an easement or court finding of a prescriptive right which are necessary to perform the Work. The UTILITY also agrees to obtain all necessary permissions for the STATE to perform the Work on such lands, which may include reasonable use restrictions on those lands. The UTILITY agrees to provide the rights of entry and applicable permissions under this section to the STATE within _____ (____) calendar days of entering into this Agreement. Upon completion of the Work on such lands, the rights of entry and permissions shall terminate.

7. GENERAL PROVISIONS

- 7.1 **Indemnification:** To the extent authorized by law, the UTILITY and STATE shall indemnify and hold harmless one another and their employees and/or officers from and shall process and defend at its own expense any and all claims, demands, suits at law or equity, actions, penalties, losses, damages (both to persons and/or property), or costs, of whatsoever kind or nature, brought against the one Party arising out of, in connection with, or incident to the other Party's performance or failure to perform any aspect of this Agreement, provided, however, that if such claims are caused by or result from the concurrent negligence of (a) the UTILITY and (b) the STATE, their respective employees and/or officers, or involves those actions covered by RCW 4.24.115, this indemnity provision shall be valid and enforceable only to the extent of the negligence of the UTILITY or STATE, and provided further, that nothing herein shall require the UTILITY or STATE to hold harmless or defend the other or its employees and/or officers from any claims arising from that Party's sole negligence or that of its employees and/or officers. The terms of this section shall survive the termination of this Agreement.

- 7.2 **Disputes:** If a dispute occurs between the UTILITY and the STATE at any time during the prosecution of the Work, the Parties agree to negotiate at the management level to resolve any issues. Should such negotiations fail to produce a satisfactory resolution, the Parties agree to enter into arbitration and/or mediation before proceeding to any other legal remedy. Each Party shall be responsible for its own fees and costs. The Parties agree to equally share the cost of a mediator or arbiter.
- 7.3 **Venue:** In the event that either Party deems it necessary to institute legal action or proceedings to enforce any right or obligation under this Agreement, the Parties hereto agree that any such action or proceedings shall be brought in the superior court situated in Thurston County, Washington. Each Party shall be responsible for its own attorneys' fees and costs.
- 7.4 **Termination:** In the event funding for the Project or Work is withdrawn, reduced, or limited in any way after the execution date of this Agreement and prior to normal completion, the STATE may terminate the Agreement upon _____ (_____) calendar day notice. In the event of such termination, the STATE and UTILITY shall consult, if necessary, on how the Work shall be brought to a level that is safe for the UTILITY's operation and maintenance. In the event the Work is terminated, the provisions of Sections 2 and 5 shall apply to the Work completed.
- 7.5 **Amendments:** This Agreement may be amended by the mutual agreement of the Parties. Such amendments or modifications shall not be binding unless put in writing and signed by persons authorized to bind each of the Parties.
- 7.6 **Independent Contractor:** Both Parties shall be deemed independent contractors for all purposes, and the employees of each Party and any of its contractors, subcontractors, consultants, and the employees thereof, shall not in any manner be deemed to be the employees of the other Party.
- 7.7 **Audit and Records:** During the progress of the Work and for a period of not less than three (3) years from the termination or completion of this Agreement, the STATE shall maintain the records and accounts pertaining to the Work and shall make them available during normal business hours and as often as necessary, for inspection and audit by the UTILITY and copies of all records, accounts, documents or other data pertaining to the Work will be furnished upon request. The UTILITY shall pay the cost of copies produced. If any litigation, claim or audit is commenced, the records and accounts along with supporting documentation shall be retained until any litigation, claim or audit finding has been resolved even though such litigation, claim or audit continues past the three-year retention period.
- 7.8 **Working Days:** Working days for this Agreement are defined as Monday through Friday, excluding Washington State holidays per RCW 1.16.050.

IN WITNESS WHEREOF, the Parties hereto have executed this Agreement as of the day and year last written below.

UTILITY

**STATE OF WASHINGTON
DEPARTMENT OF TRANSPORTATION**

By _____

By _____

Name _____

Name _____

Title _____

Title _____

Date _____

Date _____

Utility Construction Agreement Work by State – State Cost
DOT Form 224-077 EF (Page 4 of 4)

To: (Bank or Trust Company)	 Washington State Department of Transportation Escrow Agreement Utilities
Bank	
Address	
Escrow Account Number	
Contract Number	

The undersigned, _____, hereinafter referred to as the Contractor, has directed the Department of Transportation, hereinafter referred to as the Agency, to deliver to you its warrants or checks which shall be payable to you for the Contractor. Such warrants or checks are to be held and disposed of by you in accordance with the following instructions and upon the terms and conditions hereinafter set forth.

Instructions

1. The Agency shall deliver to you from time to time checks or warrants payable to you for the benefit of the Contractor. You are hereby authorized by the Contractor to endorse any such check or warrant so that you may receive the proceeds thereof and invest the same. The power of endorsement hereby granted to you by the Contractor shall be deemed a power coupled with an interest and shall be irrevocable during the term of this escrow. Although you may be a payee named in such warrants or checks as shall be delivered to you, your duties and responsibilities with respect to the same shall be only those duties and responsibilities which a depository bank would have pursuant to Article 4 of the Uniform Commercial Code of the State of Washington and RCW 39.58 et seq for an item deposited with it for collection as of the date such check or warrant shall be delivered to you. The proceeds from collections shall be used by you to purchase, as directed by the Contractor, bonds or other securities chosen by the Contractor and approved by you and the Agency. For the purpose of each such purchase, you may follow the last written direction received by you from the Contractor, provided such direction otherwise conforms with the restrictions on investments recited herein. Attached is a list of such bonds or other securities approved by the Agency. No further approval is necessary if any of these bonds or securities are selected by the Contractor, subject to express written approval of you and the Agency. Purchase of such bonds or other securities shall be in a form which shall allow you alone to reconvert such bonds or other securities into money if you are required to do so by the Agency as provided in paragraph 4 of this Escrow Agreement.

The investments selected by the Contractor, approved by the Agency and purchased by you must mature on or prior to the earlier of (i) the date set for the completion of the contract which is the subject of this Escrow Agreement (the "Contract"), including extensions thereof, or (ii) thirty days following the final acceptance of said improvement or work performed under the Contract.

2. When and as interest on the securities held by you pursuant to this Escrow Agreement accrues and is paid, you shall collect such interest and forward it to the Contractor at its address designated below, unless with your written consent you are otherwise directed in writing by the Contractor.
3. You are not authorized to deliver to the Contractor all or any part of the securities held by you pursuant to this Escrow Agreement (or any monies derived from the sale of such securities, or the negotiation of the Agency's warrants or checks) except in accordance with written instructions from the Agency or by court order or arbitration award. The Agency shall inform you and keep you informed in writing of the name of the person or persons with authority to give you such written instructions. Compliance with such instructions shall relieve you of any further liability related thereto.
4. The estimated completion date for the work to be performed under the Contract is on or about _____. Upon request by you, the Agency shall advise you in writing of any change in this estimated completion date. If the estimated completion date is changed you are authorized to reinvest the monies held hereunder in accordance with the new estimated completion date. Release of the escrow funds held hereunder to the Contractor will have a target release date of sixty (60) days after (a) contract completion, as recorded by the Agency, and (b) advertisement of contract completion in the Daily Journal of Commerce. Release of the escrow funds is also subject to the following: (i) satisfaction of any claims made pursuant to RCW 39.12 and/or RCW 60.28, and (ii) for contracts in excess of \$35,000, the receipt of appropriate releases from the Washington Department of Revenue, the Washington Employment Security Department and the Washington Department of Labor & Industries.
5. In the event the Agency is entitled to payment of the funds held hereunder and the Agency orders you to do so in writing, and not withstanding any other provisions of this Escrow Agreement, you shall, within thirty-five (35) days of receipt of such order, reconvert into money the securities held by you pursuant to this agreement and return such money together with any other monies, including accrued interest on such securities, held by you hereunder, to the Agency.
6. The Contractor agrees to pay you as compensation for your services hereunder as follows:

Payment of all fees shall be the sole responsibility of the Contractor and shall not be deducted from any property placed with you pursuant to this Escrow Agreement until and unless the Agency directs the release to the Contractor of the securities and monies held hereunder whereupon you shall be granted a first lien upon such property released and shall be entitled to reimburse yourself from such property for the entire amount of your fees and any unanticipated amounts which might be owing as provided for herein. In the event that you are made a party to any litigation with respect to the property held by you hereunder, or in the event that the conditions of this escrow are not promptly fulfilled or that you are required to render any services not provided for in these instructions, or that there is any assignment of the interests of this escrow or any modification hereof, you shall be entitled to reasonable compensation for such extraordinary services from the Contractor and reimbursement from the Contractor for all costs and expenses, including attorney fees occasioned by such default, delay, controversy or litigation.

Escrow Agreement Utilities
DOT Form 224-096 EF (Page 2 of 5)

7. Should you at any time and for any reason desire to be relieved of your obligations as escrow holder hereunder, you shall give written notice to the Agency and Contractor. The Agency and Contractor shall, within 20 days of the receipt of such notice, jointly appoint a successor escrow holder and instruct you to deliver all securities and funds held hereunder to said successor. If you are not notified of the appointment of the successor escrow holder within 20 days, you may return the subject matter hereof to the Agency and upon so doing, it absolves you from all further charges and obligations in connection with this escrow.
8. Pursuant to the attachment to this Escrow Agreement, if an election is made to deposit amounts reserved in an interest bearing account in a bank, mutual savings bank, or savings and loan association, the Contractor is to select an institution. Any bank selected must be a "qualified public depository" as defined under RCW 39.58.010. The deposits must be held in a Washington State branch of the qualified public depository as "Public Funds" and insured by the qualified public depository against loss as provided for in RCW 39.58 et seq. Each calendar year, in or about May or June, the Agency shall request, and you shall provide the Agency with, the following information concerning any funds deposited in connection with the contract and account designated herein **as of the close of business on June 30th of that year**: (i) the current balance, (ii) all payments made to you by the Agency, (iii) all interest payments made by you to the Contractor, (iv) the types of securities held (and in what proportion) and (v) any other information deemed relevant by the Agency. The Agency's letter of request shall provide you with a current list of Agency employees authorized to give you written instructions concerning the requirements of this section.
9. This agreement shall not be binding until executed by you, the Contractor, and accepted by the Agency.
10. This instrument contains the entire agreement between you, the Contractor and the Agency with respect to this escrow and you are not a party to nor bound by any instrument or agreement other than this; you shall not be required to take notice of any default or any other matter, nor be bound by nor required to give notice or demand, nor required to take any action whatever except as herein expressly provided; you shall not be liable for any loss or damage not caused by your own negligence or willful misconduct.
11. The foregoing provisions shall be binding upon the assigns, successors, personal representatives and heirs of the parties hereto.

The undersigned have read and hereby approve the instructions as given above governing the administration of this escrow and do hereby execute this agreement this day _____ of _____, _____.

Day Month Year

Contractor

Authorized Signature

Address

Printed Name/Title of Authorized Signer

City, State, Zip Code

Escrow Agreement Utilities
DOT Form 224-096 EF (Page 3 of 5)

_____	_____
Bank or Trust Company	Contact Phone Number
_____	_____
Authorized Signature	Contact Name
_____	_____
Printed Name/Title of Authorized Signer	Escrow Account Number assigned to this contract

The above escrow agreement received and accepted by Bank or Trust Company, this _____ Day
day of _____, _____
Month Year

Washington State Department of Transportation
Agency

WSDOT AFS Authorized Signature

The escrow agreement accepted this _____ day of _____,
Day Month Year

DOT Form 224-096 EF
Revised 07/2012

Page 4 of 5

Escrow Agreement Utilities
DOT Form 224-096 EF (Page 4 of 5)

List of Type of Bonds or Securities that are Approved by the Department of Transportation.

Please indicate which type of Bonds or Securities that have been selected by checking the appropriate number below.

1. Bills, certificates, notes or bonds of the United States.
2. Other obligations of the United States or its agencies.
3. Obligations of any corporation wholly-owned by the government of the United States.
4. Indebtedness of the Federal National Mortgage Association.
5. Time deposits in Commercial Banks, Mutual Savings Banks or Savings and Loan Associations.
6. Interest Bearing Accounts. When an election is made to deposit amounts reserved in an interest bearing account in a bank, mutual savings bank, or savings and loan association, the Contractor is to select an institution. Any bank selected must be a qualified public depository under RCW 39.58.010.

Funds applied to this account are sent from the Agency and cannot be withdrawn by the contractor without the Agency's written authorization. The amounts deposited are not to be subject to withdrawal until such time as the Agency releases them. Release of such funds to the Contractor will be made pursuant to Section 4. of this Escrow Agreement.

Interest earned on deposits is to be paid to the Contractor as said interest becomes payable under the terms of the deposit, pursuant to Section 2. of this Escrow Agreement. The account is to be appropriately noted by the bank, savings bank, or savings and loan association to enable that institution to report interest payments made to the Contractor to the Internal Revenue Service in the proper format.

In no event shall the Department of Transportation approve investments in stock of any company, association or corporation. In all cases, the investments selected must mature on or prior to the date set for completion of the contract, including extensions thereof.



Utility Preliminary Engineering Agreement
Work by State – Utility Cost

Agreement Number			Region		Utility Name and Address	
Control Section		State Route	Mileposts From To		Project Title / Location	
Estimated Agreement Amount				Advanced Payment Amount		

This Utility Preliminary Engineering Agreement is made and entered into between the State of Washington Department of Transportation, herein (STATE) and the above named UTILITY.

WHEREAS, the STATE is planning the construction or improvement of the State Route as shown above for the identified STATE Project, and in connection therewith, it is necessary to remove and/or relocate or construct certain UTILITY facilities, and

WHEREAS, it is deemed to be in the best public interest for the STATE to develop the preliminary engineering, including the preparation of plans, specifications and cost estimate, herein the "Work," for the removal, relocation and/or construction of the UTILITY's facilities as part of the STATE's Project, and

WHEREAS, the STATE and the UTILITY intend to enter into a Utility Construction Agreement to cover the actual construction, relocation, and/or removal of the UTILITY's facilities, and

WHEREAS, the UTILITY is responsible for (1) the cost of the Work associated with UTILITY facilities located without a documented ownership of and/or interest in real property, such as being located pursuant to a franchise, a permit, or undocumented permission, (2) all betterments, and (3) new facilities,

NOW, THEREFORE, pursuant to RCW 47.01.210 and chapter 47.44 RCW and in consideration of the terms, conditions, covenants, and performances contained herein, as well as the attached Exhibits which are incorporated and made a part hereof,

IT IS MUTUALLY AGREED AS FOLLOWS:

1. PLANS, SPECIFICATIONS AND ESTIMATES

- 1.1 Program Guide: *Utility Relocation and Accommodation on Federal Aid Highway Projects* shall determine and establish the definitions and applicable standards and payments for this Agreement. By this reference said document is adopted and made a part of this Agreement as if fully contained herein.
- 1.2 Betterment: A betterment is any improvement to the UTILITY's facilities not required by code, regulation, standard industry practice, or any other applicable regulation. If any of the Work constitutes a betterment as defined in the Program Guide: *Utility Relocation and Accommodation on Federal Aid Highway Projects*, the UTILITY is solely responsible for the preliminary engineering costs of such improvement.
- 1.3 The STATE agrees to perform, at the UTILITY's sole cost and expense, the preliminary engineering, including the preparation of plans, specifications and cost estimate, herein the "Work," for the removal, relocation and/or construction of the UTILITY's facilities as part of the STATE's Project to the UTILITY's specifications and/or requirements. The UTILITY agrees to provide the STATE all applicable standards, industry requirements, regulations, codes, or other pertinent information prior to performing the Work. Exhibit A, Special Provisions, including a Scope of Work, and Exhibit C, Plans, are attached.

- 1.4 The UTILITY agrees that when the STATE performs the Work and a consultant is designing the STATE Project, the STATE consultant may also be utilized for the purposes of performing the Work, including incorporating the Work into the STATE construction contract.
- 1.5 The STATE shall provide the Work to the UTILITY for review and approval. The UTILITY agrees to review the Work within _____ (_____) working days and shall: (a) deliver a letter of acceptance to the STATE which shall include a release and waiver of all future claims or demands of any nature resulting from the performance of the Work, or (b) deliver to the STATE written reasons why the Work does not comply with the applicable standards, industry requirements, regulations, codes or other pertinent information supplied by the UTILITY. The UTILITY agrees to work diligently and in good faith with the STATE to resolve any issues so as not to delay advertisement of the STATE Project. If all issues are resolved, the UTILITY agrees to deliver to the STATE a letter of acceptance of the Work which includes a release and waiver of all future claims or demands of any nature resulting from the performance of the Work.
- 1.6 The UTILITY shall be responsible for all costs it incurs in reviewing the Work.
- 1.7 The Parties agree that the STATE is under no obligation to the UTILITY to perform the Work, except as agreed to under this Agreement. Therefore, if the inclusion of the UTILITY Work threatens to delay the STATE's Project, the STATE shall have the unilateral authority to delete the UTILITY Work from the STATE Project and terminate this Agreement. The STATE shall immediately notify the UTILITY of such actions. The UTILITY agrees that it will be responsible for costs incurred by the STATE up to the date of termination, and the STATE agrees to provide to the UTILITY all Work-related documents upon final payment by the UTILITY.
- 1.8 The UTILITY agrees that should the Work be terminated, it shall continue to be obligated to timely design remove, relocate and/or construct its facilities as required by the STATE Project. The UTILITY further agrees that should its actions delay or otherwise damage the STATE Project, it shall be liable for such costs.

2. PAYMENT

- 2.1 The UTILITY agrees that it shall be responsible for the actual direct and related indirect costs of the Work to be performed by the STATE. An itemized estimate of UTILITY-responsible costs for Work to be performed by the STATE on behalf of the UTILITY is included in Exhibit B, Cost Estimate, attached.
- 2.2 The UTILITY agrees to pay the STATE the "Advance Payment Amount" stated above within twenty (20) calendar days after the STATE submits its first partial payment request to the UTILITY. The advance payment represents fifteen (15) percent of the estimate of cost for which the UTILITY is responsible. The advance payment will be carried throughout the life of the Work with final adjustment made in the final invoice.
- 2.3 The Parties acknowledge and agree that the STATE does not have the legal authority to advance state funds for the UTILITY's Work under this Agreement. Should the UTILITY fail to make payment according to the terms of this Agreement, the STATE shall have the right to terminate this Agreement, charging the UTILITY for all costs up to the date of termination and all non-cancellable items. The STATE agrees to provide to the UTILITY all Work-related documents upon final payment by the UTILITY.
- 2.4 The UTILITY, in consideration of the faithful performance of the Work to be performed by the STATE, agrees to pay the STATE for the actual direct and related indirect cost of all Work for which the UTILITY is responsible. The STATE shall invoice the UTILITY and provide supporting documentation therefore, and the UTILITY agrees to pay the STATE within thirty (30) calendar days of receipt of an invoice. A partial payment will not constitute agreement as to the appropriateness of any item and that, at the time of final payment, the Parties will resolve any discrepancies.

3. CHANGE IN WORK OR COST INCREASE

- 3.1 Increase in Cost: In the event unforeseen conditions require an increase in the cost of the Work for which the UTILITY is responsible, the Exhibit B, Cost Estimate (including sales tax, engineering, and contingencies) by more than _____ (_____) percent, the Parties agree to modify Exhibit B to include such cost increase.

- 3.2 If a change in Project design occurs that will affect the Work, the STATE will inform the UTILITY, in writing, of such change and the UTILITY shall respond giving notice of its acceptance or rejection of the change, in writing within _____ (____) working days of receiving the notice. If the UTILITY rejects the change, the Parties agree to diligently and in good faith work together to reach a mutual resolution. Otherwise, either Party may terminate this Agreement. If terminated, the UTILITY agrees to pay all costs incurred up to the date of termination, including non-cancellable items, and the STATE agrees to provide to the UTILITY all Work-related documents upon final payment by the UTILITY. The UTILITY agrees that should the Work be terminated, it shall continue to be obligated to timely design, remove, relocate and/or construct its facilities as required by the STATE Project. The UTILITY further agrees that should its actions delay or otherwise damage the STATE Project, it shall be liable for such costs.

4. RIGHT OF ENTRY

- 4.1 The UTILITY agrees to arrange for rights of entry upon all privately owned lands upon which the UTILITY has an easement, documented property interest, or permit that are necessary to perform the Work. The UTILITY also agrees to obtain all necessary permissions for the STATE to perform the Work on such lands, which may include reasonable use restrictions on those lands. The UTILITY agrees to provide the rights of entry and applicable permissions to the STATE within _____ (____) calendar days of entering into this Agreement. Upon completion of the Work on such lands, the rights of entry and permissions shall terminate.

5. GENERAL PROVISIONS

- 5.1 Indemnity: To the extent authorized by law, the UTILITY and STATE shall indemnify and hold harmless one another and their employees and/or officers from and shall process and defend at its own expense any and all claims, demands, suits at law or equity, actions, penalties, losses, damages (both to persons and/or property), or costs, of whatsoever kind or nature, brought against the one Party arising out of, in connection with, or incident to the other Party's performance or failure to perform any aspect of this Agreement; provided however, that if such claims are caused by or result from the concurrent negligence of (a) the UTILITY and (b) the STATE, their employees, and/or officers, or involves those actions covered by RCW 4.24.115, this indemnity provision shall be valid and enforceable only to the extent of the negligence of the UTILITY or STATE, and provided further, that nothing herein shall require the UTILITY or STATE to hold harmless or defend the other or its employees and/or officers from any claims arising from that Party's sole negligence or that of its employees and/or officers. The terms of this section shall survive the termination of this Agreement.
- 5.2 Disputes: If a dispute occurs between the UTILITY and the STATE at any time during the performance of the Work, the Parties agree to negotiate at the management level to resolve any issues. Should such negotiations fail to produce a satisfactory resolution, the Parties agree to enter into arbitration and/or mediation before proceeding to any other legal remedy. Each Party shall be responsible for its own fees and costs. The Parties agree to equally share in the cost of a mediator or arbiter.
- 5.3 Venue: In the event that either Party deems it necessary to institute legal action or proceedings to enforce any right or obligation under this Agreement, the Parties hereto agree that any such action or proceedings shall be brought in the superior court situated in Thurston County, Washington. Further, the Parties agree that each shall be responsible for its own attorney fees and costs.
- 5.4 Termination:
- 5.4.1 Unless otherwise provided herein, the UTILITY may terminate this Agreement upon thirty (30) calendar days written notice to the STATE. If this Agreement is terminated by the UTILITY prior to the fulfillment of the terms stated herein, the STATE shall be reimbursed for all actual direct and related indirect expenses and costs incurred up to the date of termination associated with the UTILITY Work. Further, the UTILITY acknowledges and agrees that should it terminate this Agreement, such termination shall not relieve the UTILITY from its responsibility to design, remove, relocate and/or construct its facilities so as not to delay or conflict with the STATE's project. The STATE agrees to provide to the UTILITY all Work-related documents upon final payment by the UTILITY.

5.4.2 Unless otherwise provided herein, the STATE may terminate this Agreement, upon thirty (30) days written notice to the UTILITY. Should the STATE terminate this Agreement, the UTILITY shall reimburse the STATE for all actual direct and related indirect expenses and costs incurred by the STATE up to the date of termination. The UTILITY acknowledges and agrees that should the STATE terminate this Agreement, such termination shall not relieve the UTILITY from its responsibility to design, remove, relocate and/or construct its facilities so as not to delay or conflict with the STATE's Project. The STATE agrees to provide to the UTILITY all Work-related documents upon final payment by the UTILITY.

5.5 Amendments: This Agreement may be amended by the mutual agreement of the Parties. Such amendments or modifications shall not be binding unless put in writing and signed by persons authorized to bind each of the Parties.

5.6 Independent Contractor: Both Parties shall be deemed independent contractors for all purposes, and the employees of each Party and any of its contractors, subcontractors, consultants, and the employees thereof, shall not in any manner be deemed to be the employees of the other Party.

5.7 Audit and Records: During the progress of the Work and for a period of not less than three (3) years from the date of final payment, both Parties shall maintain the records and accounts pertaining to the Work and shall make them available during normal business hours and as often as necessary, for inspection and audit by the other Party, State of Washington, and/or Federal Government and copies of all records, accounts, documents or other data pertaining to the Work will be furnished upon request. The requesting Party shall pay the cost of copies produced. If any litigation, claim or audit is commenced, the records and accounts along with supporting documentation shall be retained until any litigation, claim or audit finding has been resolved even though such litigation, claim or audit continues past the three-year retention period.

5.8 Working Days: Working days are defined as Monday through Friday, excluding Washington State holidays per RCW 1.16.050

IN WITNESS WHEREOF, the Parties hereto have executed this Agreement as of the day and year last written below.

UTILITY

**STATE OF WASHINGTON
DEPARTMENT OF TRANSPORTATION**

By _____

By _____

Name _____

Name _____

Title _____

Title _____

Date _____

Date _____

Utility Preliminary Engineering Agreement Work by State – Utility Cost
DOT Form 224-301 EF (Page 4 of 4)



Application for Utility Permit or Franchise

Permit/Franchise No.

Applicant - Please print or type all information

Application is Hereby Made For: Permit Category 1 \$500.00
 Franchise Amendment Category 2 \$300.00
 Franchise Consolidation \$300.00 Category 3 \$150.00
 Franchise Renewal \$250.00

Intended Use of State Right of Way is to Construct, Operate, and Maintain a:

_____ on a portion of
 State Route _____ (at/from) MilePost _____ to Mile Post _____ in _____ County,
 to begin in the _____ Section _____ Township _____ North: Range _____ East W.M.
 and end in the _____ Section _____ Township _____ North: Range _____ East W.M.

Fees in the amount of \$ _____ are paid to cover the basic administrative expenses incident to the processing of this application according to WAC 468-34 and RCW 47.44 and amendments thereto. The applicant promises to pay any additional costs incurred by the Washington State Department of Transportation (Department) on the behalf of the applicant.

Checks or Money Orders are to be made payable to "Washington State Department of Transportation."

Applicant (Referred to as Utility) _____	Applicant Authorized Signature _____
Address _____	Print or Type Name _____
City _____ State _____ Zip Code _____	Title _____
Telephone _____	Dated this _____ day of _____, _____
Applicant Reference (WO) Number _____	Federal Tax ID Number or Social Security Number _____

Authorization to Occupy Only If Approved Below

The Department hereby grants this Permit or Franchise, as applicable, subject to the terms and conditions stated in the General Provisions, Special Provisions, and Exhibits attached hereto and by this reference made a part hereof.

For Department Use Only

Exhibits Attached	<p style="text-align: center;">Department Approval</p> By: _____ Title: _____ Date: _____ Expiration Date: _____
-------------------	--

General Provisions

This Permit or Franchise is issued pursuant to the terms of RCW 47.32, RCW 47.44, and WAC 468-34, and amendments thereto. Renewal of a Franchise must be by application prior to expiration of this Franchise as required by RCW 47.44.020(3).

1. A copy of this Permit or Franchise must be on the job site, protected from the elements, at all times during any construction authorized by this Permit or Franchise.
2. The Utility agrees to pay the reasonable costs for investigating, handling, and granting the Permit or Franchise, including, but not limited to basic overhead charges and for providing an inspector during construction and/or maintenance of the Utility's facilities. Further, the Utility agrees that it shall be responsible for and pay the Department's expended direct and indirect costs associated with applicable provisions of the Permit or Franchise.
 - (a) The Department will assign a reimbursable account to the Utility as a means of invoicing the Utility for the costs associated with this Permit or Franchise.
 - (b) The Department will invoice the Utility and the Utility agrees to pay the Department within thirty (30) calendar days of receipt of an invoice.
3. Upon approval of this Permit or Franchise, the Utility shall diligently proceed with the Work and comply with all General and Special provisions herein. Construction of facilities proposed under this Permit or Franchise shall begin within one (1) year and must be completed within three (3) years from date of Department approval. "Work" under this Permit or Franchise shall mean construction, operation, and maintenance of the Utility's facilities as authorized herein.
4. The Utility shall notify the Department representative in special provision 1 of the name, address, and telephone number of its contractor when Work outlined herein is going to be performed with other than its own forces. When the Utility uses a contractor, an authorized representative of the Utility shall be present or available at all times unless otherwise agreed to by the Department representative. A list of authorized representatives shall be submitted prior to the construction start date. (Authorized representatives are defined as persons having signatory authority for the Utility and or the authority to control the Work as needed for any issues identified by the Department.)
5. The Utility agrees to schedule and perform its Work in such a manner as not to delay the Department's contractor's work when the Department has a contractor performing work in the vicinity of the Utility's Work.
6. All contact between the Department and the Utility's contractor shall be through the Utility representative. Where the Utility chooses to perform the Work with its own forces, it may elect to appoint one of its own employees engaged in the Work as its representative. The Utility, at its own expense, shall adequately police and supervise all Work performed by itself, its contractor, subcontractor, agent, and/or others, so as not to endanger or injure any person or property.
7. The Utility shall contact the identified Department representative two (2) weeks prior to conducting Work, to determine the location of survey control monuments within the area in which the Utility will be working. In the event any monument or right of way marker will be altered, damaged, or destroyed by the Utility, the Department, prior to Utility Work, will reference or reset the monument or right of way marker. During the Work, upon discovery of a monument or right of way marker, the Utility shall cease Work in that area and immediately notify the Department of the discovery. The Department will coordinate with the Utility to ensure that the monument or right of way marker is recorded or replaced. The Utility agrees to pay all Department costs to perform monument or right of way marker work, as provided in this provision, in accordance with general provision 2.
8. In the event any milepost, fence, or guardrail is located within the limits of the Utility's Work and will be disturbed during Utility Work, the Utility agrees to carefully remove these highway facilities prior to Utility Work and reset or replace these highway facilities after the Utility Work, to the Department's sole satisfaction and at the sole cost of the Utility. The Utility agrees that all highway signs and traffic control devices shall not be removed or disturbed during Utility Work.
9. The Utility agrees that all Work shall be done to the satisfaction of the Department. All material and workmanship shall conform to the Department's *Standard Specifications for Road, Bridge, and Municipal Construction*, current edition, and amendments thereto, and shall be subject to Department inspection. All Department acceptance and inspections are solely for the benefit of the Department and not for the benefit of the Utility, the Utility's contractor (if any), or any third party. The Utility agrees that it shall pay all Department inspection costs in accordance with general provision 2.

10. The Utility shall comply with the *Manual on Uniform Traffic Control Devices for Streets and Highways* (Federal Highway Administration) and the State of Washington modifications thereto (chapter 468-95 WAC) while it performs the Work. If the Department requires, the Utility shall submit a signing and traffic control plan to the Department's representative for approval prior to construction or maintenance Work. No lane closures shall be allowed except as approved by the Department's representative. Approvals may cause revision of Special Provisions of this Permit or Franchise, including hours of operation.
11. This Permit or Franchise may not be amended or modified without the Department's prior review and approval. Upon completion of the Work, the Utility shall provide a written notice of completion of the Work to the Department's representative within ten (10) calendar days of the completion of the Work so that the Department may make its final inspection. Further, the Utility shall provide the Region Utilities Engineer with detailed as-built drawings within ninety (90) calendar days of Work completion, if the originally approved Permit or Franchise construction plans have been revised during the course of construction.
12. If the Department, at its sole discretion, shall determine that any or all of the Utility's facilities must be modified, removed from, or relocated within the state-owned highway right of way as necessary, incidental, or convenient for the construction, alteration, improvement, repair, relocation, or maintenance of the state highway, or for the safety of the traveling public, the Utility, its successors and assigns, shall, at its sole cost and expense, upon written notice by the Department, modify, relocate, or remove any or all of its facilities within or from the state-owned highway right of way as required by the Department. The Utility shall perform in a timely manner all facility modifications, relocations, and/or removals as the Department directs, to avoid highway project impacts or delays and in such manner as will cause the least disruption of traffic or interference with the Department's continued operation and/or maintenance of the highway.
13. Should the Utility fail or refuse to comply with the Department's direction, pursuant to general provision 9, to modify, remove, or relocate any Utility facility, the Department may undertake and perform any modification, removal, or relocation of the Utility facility that the Department, in its sole discretion, deems necessary. The Utility agrees to pay the Department's expended costs and expenses for performing the work, in accordance with general provision 2.
14. If the Department determines in good faith that emergency maintenance work on the Utility's facility is needed to (a) protect any aspect of the state highway right of way, or (b) secure the safety of the traveling public due to a failure of the Utility's facility, the Department may perform the necessary work without the Utility's prior approval, and the Utility agrees to pay the Department's expended costs and expenses for performing the work in accordance with general provision 2. The Department will notify the Utility of the emergency work performed as soon as practicable.
15. The Department may amend, revoke, or cancel this Permit or Franchise at any time by giving written notice to the Utility. If the Permit or Franchise is amended, the Utility will have thirty (30) calendar days to modify the facility as the Permit or Franchise amendment(s) require. If the facility modifications cannot be made within thirty (30) calendar days, the Utility shall respond to the Department, in writing, as to when the facility modifications can be made. If the Permit or Franchise is revoked or canceled, the Utility shall immediately remove all facilities from the right of way. Any facilities remaining upon the right of way thirty (30) calendar days after written notice of Permit or Franchise revocation or cancellation may be removed by the Department at the expense of the Utility. The Utility agrees to pay the Department's expended costs and expenses for performing the work in accordance with general provision 2.
16. Should the Utility breach any of the conditions and requirements of this Permit or Franchise, or should the Utility fail to proceed with due diligence and in good faith with the Work as authorized by this Permit or Franchise, the Department may cancel or revoke the Permit or Franchise upon thirty (30) calendar days written notice to the Utility.
17. The Utility shall not excavate or place any obstacle within the state-owned highway right of way in such a manner as to interfere with the Department's construction, operation, and maintenance of the state-owned highway right of way or the public's travel thereon without first receiving the Department's written authorization.
18. The Utility agrees to maintain, at its sole expense, its facilities authorized by this Permit or Franchise in a condition satisfactory to the Department.
19. The Utility agrees that it is financially responsible to the Department for all necessary expenses incurred in inspecting the construction and restoring the highway pavement or related transportation equipment or facilities to a permanent condition suitable for travel as determined by the Department, as well as financially responsible to the Department for trenching work not completed and for compensating the Department for the loss of useful pavement life caused by trenching as required by RCW 47.44.020.

20. Upon completion of all Work, the Utility shall immediately remove all rubbish and debris from the state-owned highway right of way, leaving the state-owned highway right of way in a neat, presentable, and safe condition to the Department's satisfaction. Any Work-related rubbish and debris clean up, or any necessary slope treatment to restore and/or protect the state-owned right of way, not done within one (1) week of Work completion, unless otherwise negotiated, will be done by the Department at the expense of the Utility. The Utility agrees to pay the Department's expended costs and expenses for performing the work in accordance with general provision 2.
21. For the benefit and safety of the traveling public, the Utility voluntarily agrees to permit the Department to attach and maintain upon any Utility facility under this Permit or Franchise any required traffic control devices, such as traffic signals, luminaires, and overhead suspended signs, when the use of such devices or attachments does not interfere with the use for which the facility was constructed. The Department shall bear the cost of attachment and maintenance of such traffic control devices, including the expended cost of any extra Utility infrastructure construction beyond what is necessary for the Utility's facility; such extra cost to be jointly determined by the Department and the Utility. The Department shall not share in the Utility facilities' cost of installation, operation, or maintenance of any of the facilities installed under this Permit or Franchise.
22. The Utility shall comply with the Department's *Highway Runoff Manual* (M 31-16) and any revisions thereto, for erosion control and/or to mitigate any erosion occurring as a result of the Work. If the Utility Work performed under this Permit or Franchise alters, modifies, changes, or interferes in any way with the drainage of the state-owned highway right of way, the Utility shall, at its own expense, make all corrections and/or provisions the Department requires to fix and restore the state-owned right of way drainage to its original condition and function prior to the Utility's Work. Should the Utility not make the required drainage restoration, the Department reserves the right to make such changes as necessary to restore the original drainage function at the sole cost of the Utility, and the Utility agrees to pay the Department's expended costs and expenses for performing the work in accordance with general provision 2.
23. The Utility shall be responsible for securing all necessary permits, including but not limited to, federal, state, and local regulatory, tribal, environmental, archeological, and railroad permits and permits from the Washington State Department of Ecology, the Washington State Department of Fish and Wildlife, and/or the U.S. Army Corps of Engineers prior to beginning the Work authorized by this Permit or Franchise. The Utility shall be responsible for mitigation measures where wetlands have been disturbed and agrees that it is responsible for any fines imposed for noncompliance with the permit(s) conditions or for failure to obtain the required permits. In addition, the Utility, on behalf of itself and its contractors, officers, officials, employees, and agents, agrees to indemnify, hold harmless, and defend, at its sole cost and expense, the Department and its officers, officials, employees, and agents from any and all fines, costs, claims, judgments, and/or awards of damages (to regulatory agencies, persons, and/or property), arising out of, or in any way resulting from, the Utility's failure to (1) obtain any required permit for the Utility Work or (2) comply with permit conditions. Further, the Utility shall be responsible for compliance with all federal, state, and local laws, regulations.
24. For any of the Utility's Work that requires permit coverage under the "CONSTRUCTION STORMWATER GENERAL PERMIT – National Pollutant Discharge Elimination System and State Waste Discharge General Permit for Stormwater Discharges Associated with Construction Activity" (Construction Stormwater General Permit), the Utility shall obtain said permit coverage and shall comply with all requirements of the Construction Stormwater General Permit. Upon the Department's request, the Utility shall provide a copy of the Construction Stormwater General Permit. In addition, the Utility, on behalf of itself and its contractors, officers, officials, employees, and agents, agrees to indemnify, hold harmless, and defend, at its sole cost and expense, the Department and its officers, officials, employees, and agents from any and all fines, costs, claims, judgments, and/or awards of damages (to regulatory agencies, persons, and/or property), arising out of, or in any way resulting from, the Utility's failure to (1) obtain coverage under the Construction Stormwater General Permit for Utility Work or (2) comply with the Construction Stormwater General Permit requirements.
25. This Permit or Franchise does not authorize the Utility, or its employees, contractors, or agents, any right to cut, spray, retard, remove, destroy, disfigure, or in any way modify the physical condition of any vegetative material located on the state-owned highway right of way. Should the Utility anticipate that its Work will alter the appearance of the state-owned highway right of way vegetation, the Utility shall notify the Department representative listed in special provision 2 to obtain the Department's prior written approval of the Utility's proposed work. If the Department permits the Utility to modify the state-owned highway right of way vegetation, it agrees that any vegetation cutting and/or trimming activities shall be conducted in such a manner that the state-owned highway right of way vegetation appearance will not be damaged. Should the Utility damage the appearance of the state-owned highway right of way vegetation without the Department's prior written approval, the Utility is subject to penalties provided for in RCWs 47.40.070, 47.40.080, and 4.24.630, as applicable.

26. The Utility hereby certifies that its facilities described in this Permit or Franchise are (1) in compliance with the Control Zone Guidelines, or (2) for a franchise consolidation or renewal, a mitigation plan has been submitted and approved for any existing Location I or Location II utility objects to be corrected in accordance with the Control Zone Guidelines, pursuant to Chapter 9 of the Department's *Utilities Manual* (M 22-87) and any revisions thereto.
27. The Utility shall not assign or transfer this Permit or Franchise without the Department's prior written approval. The Utility understands that any assignment or transfer requires the assignee or transferee to have the means to assume all obligations, duties, and liabilities of the terms and conditions of this Permit or Franchise, and the Utility will advise the assignee or transferee of its obligation to apply for an updated or replacement Permit or Franchise. If the Department does not approve the assignment or transfer, this Permit or Franchise shall automatically terminate, and the facility occupying state-owned highway right of way shall be subject to the terms of RCW 47.44.060.
28. The Utility, its successors and assigns, shall indemnify, defend at its sole cost and expense, and hold harmless the State of Washington, its officers and employees, from all claims, demands, damages (both to persons and/or property), expenses, regulatory fines, and/or suits that (1) arise out of or are incident to any acts or omissions of the Utility, its agents, contractors, and/or employees, in the use of the state-owned highway right of way as authorized by the terms and conditions of this Permit or Franchise, or (2) are caused by the breach of any of the terms or conditions of this Permit or Franchise by the Utility, its successors and assigns, and its contractors, agents, and/or employees. The Utility, its successors and assigns, shall not be required to indemnify, defend, or hold harmless the State of Washington, its officers and/or employees, if the claim, suit, or action for damages (both to persons and/or property) is caused by the acts or omissions of the State of Washington, its officers and/or employees; provided that, if such claims, suits, or actions result from the concurrent negligence of (a) the State of Washington, its officers and/or employees, and (b) the Utility, its agents, contractors, and/or employees, or involves those actions covered by RCW 4.24.115, the indemnity provisions provided herein shall be valid and enforceable only to the extent of the acts or omissions of the Utility, its agents, contractors, and/or employees.
29. The Utility agrees that its obligations under this Permit or Franchise extend to any claim, demand, and/or cause of action brought by, or on behalf of, any of its employees or agents while performing Work under this Permit or Franchise while located on state-owned highway right of way. For this purpose, the Utility, by MUTUAL NEGOTIATION, hereby waives, with respect to the State of Washington only, any immunity that would otherwise be available to it against such claims under the Industrial Insurance provisions in chapter 51.12 RCW.
30. The indemnification and waiver provided for in general provisions 28 and 29 shall survive the termination of this Permit or Franchise.
31. Any action for damages against the State of Washington, its agents, contractors, and/or employees, arising out of damages to a utility or other facility located on state-owned highway right of way, shall be subject to the provisions and limitations of RCW 47.44.150.
32. This Permit or Franchise shall not be deemed or held to be an exclusive one and shall not prohibit the Department from granting rights of like or other nature to other public or private utilities, nor shall it prevent the Department from using any of the state-owned highway right of way or other properties for transportation purposes, or affect the Department's right to full supervision and control over all or any part of the state-owned highway right of way or properties, none of which is hereby surrendered. Further, the Department reserves the exclusive right to require that all utility facilities be subject to joint trenching and occupancy.



Application for Utility Permit or Franchise for United States Government Agencies

Permit/Franchise No.

Applicant - Please print or type all information

Application is Hereby Made For: Permit Category 1
 Franchise Amendment Category 2
 Franchise Consolidation Category 3
 Franchise Renewal

Intended Use of State Right of Way is to Construct, Operate, and Maintain a: _____ on a portion of
 State Route _____ (at/from) MilePost _____ to Mile Post _____ in _____ County,
 to begin in the _____ Section _____ Township _____ North: Range _____ West/East W.M.
 and end in the _____ Section _____ Township _____ North: Range _____ West/East W.M.

The Applicant agrees to reimburse the Department for additional costs incurred that are beyond the basic administrative expense incident to the processing of this application in accordance with WAC 468-34 and RCW 47.44 and amendments.

Applicant (Referred to as Utility)	Applicant Authorized Signature
Address	Print or Type Name
City _____ State _____ Zip Code _____	Title _____
Telephone _____	Dated this _____ day of _____, _____
Applicant Reference (WO) Number _____	Federal Tax ID Number or Social Security Number _____

Authorization to Occupy Only If Approved Below

The Washington State Department of Transportation referred to as the "Department," hereby grants this document (Permit or Franchise as applicable) subject to the terms and conditions stated in the General Provisions, Special Provisions, and Exhibits attached hereto and by this reference made a part hereof. Construction facilities proposed under this application shall begin within one year and must be completed within three years from date of approval.

For Department Use Only

Exhibits Attached	<p>Department Approval</p> <p>By: _____</p> <p>_____</p> <p>Title: _____</p> <p>Date: _____</p> <p>Expiration Date: _____</p>
-------------------	--

DOT Form 224-699 EF
Revised 1/2010

General Provisions Applicable to United States Government Agencies

1. This permit/franchise is subject to the applicable provision of WAC 468-34 and amendment there to, except that any provision in this permit/franchise not consistent with Chapter 468-34 WAC shall be controlling.
2. No excavation shall be made or obstacle placed within the limits of the State highway in such a manner as to interfere with the travel over said road unless authorized by the Department.
3. If the work done under this permit/franchise interferes in any way with the drainage of the state highway, the Utility shall wholly and at its own expense, make such provision as the Department may direct to take care of said drainage.
4. On completion of this work, all rubbish and debris shall be immediately removed and the roadway and roadside shall be left neat and presentable and satisfactory to the Department.
5. All of the work herein contemplated shall be done to the satisfaction of the Department.
6. The Department hereby reserves the right to order the change of location or the removal of any structure or structures authorized by this permit/franchise at any time, said change or removal to be made at the sole expense of the Utility or their successors and assigns. Any changes, reconstruction or relocation by the Utility shall be done in such manner as will cause the least interference with any of the State's work and the State of Washington shall in no wise be held liable for any damage to the Utility by reason of any such work by the State of Washington, its agents or representatives, or by the exercise of any rights by the State upon roads, streets, public places or structures.
7. This document shall not be deemed or held to be an exclusive one and shall not prohibit the Department from granting rights of like or other nature or other public or private utilities, nor shall it prevent the Department from using any of its roads, streets, or public places, or affect its right to full supervision and control over all or any part of them, none of which is hereby surrendered.
8. The Department may for violation for any of the terms revoke, amend or cancel this permit or any of the provisions hereof after 60 days written notice to the Utility. The Utility shall then remove all facilities from the right of way. Any facilities remaining upon the right of way 30 days after cancellation of this permit shall be removed by the Department at the expense of the Utility.
9. The Utility shall maintain at its sole expense the structure or object for which this permit/franchise is granted in a condition satisfactory to the Department.
10. The Utility shall be responsible for any loss or damage to property or injury to persons resulting from any acts or omissions in accordance with the provisions of the Federal Tort Claims Act 62 Stat. 982, as amended.
11. All installations placed upon the right of way by the Utility shall be and remain the property of the Utility and may be removed any time by the Utility upon prior notification to the Department.
12. Whenever it is deemed necessary for the benefit and safety of the traveling public, the Department hereby reserves the right to attach and maintain upon any facility by the Utility under this document any required traffic control devices, such as traffic signals, luminaires, and overhead suspended signs, when the use of such devices or attachments does not interfere with the use for which the facility was constructed. The Department shall bear the cost of attachment and maintenance of such traffic control devices, including the reasonable cost of any extra construction beyond normal; such extra cost to be determined jointly by the Department and the Utility of this document. It is not to be construed that the Department is to share in the normal cost of installation, operation, or maintenance of any of the facilities installed under this document.
13. All expenditures to be made by the Utility under the provisions of this permit/franchise shall be subject to appropriations being available for the purpose.
14. On or before the termination of this permit/franchise, the Utility will remove all installations and appurtenances from the premises of the Department and restore said premises to the conditions existing at the time of entering upon the same under this permit/franchise, reasonable and ordinary wear and tear and damage by the elements or by circumstances over which the Utility has no control excepted.
15. No member of or delegate to Congress, or resident commissioner, shall be admitted to any share or part of this permit/franchise or to any benefit to arise therefrom, but this provision shall not be construed to extend to this contract if made with a corporation for its general benefit.
16. No assignment or transfer of this franchise in any manner whatsoever shall be valid nor vest any rights hereby granted until the Department consents thereto and the assignee accepts all terms of this franchise. Attempting to assign this franchise without Department consent shall be cause for cancellation as herein provided.
17. The Utility hereby certifies that the facilities described in this document are either (1) in compliance with the Control Zone Guidelines, or (2) any existing Location I or Location II utility objects will be corrected in accordance with Control Zone Guidelines.

DOT Form 224-699 EF
Revised 1/2010

Application for Utility Permit or Franchise for United States Government Agencies DOT Form 224-699 EF (Page 2 of 2)



Inspector's Daily Report

IDR Sheet _____ of _____ Sheets	
Contract _____	SR Nos. _____ Day _____ Date _____
Weather (See Instructions) AM _____ PM _____	
Prime Contractor A. _____	Representative / Title _____
Subcontractor or Lower Tier Sub	Appr'd DBE Representative / Title
B. _____	_____
C. _____	_____
D. _____	_____
E. _____	_____

Work Activity Summary

Description and Location

Pay Note Made Today?
 No - Work not complete. Will complete Paynote on completion or at estimate cutoff.
 No - LS Item. Work is not completed. Will complete paynote on completion or percentage at estimate cutoff.
NOTE: Any "No" below will be explained in Diary.
Required Backup Samples Taken
Matis Documentation Approved
Matis Source Approved

Item, Description, and Location of Work (NOTE: Any "NO" is to be explained in Diary)

Item No.	Contract Item Description	Location	Y/N	Y/N	Y/N	Y/N

Contractor's Equipment

Operating Contractor's ID (A-E, see above)

No.	Equipment - ID No. and Description	Opr	Stdbly	Down	Idle

Contractor's Workforce

Operating Contractor's ID (A-E, see above)

	Number / Total Hours								Number			
	Laborers	Carpenters	Operators	Teamsters	Ironworkers	Masons	Flaggers	Electricians	Male	Female	Appr	Trnee
	/	/	/	/	/	/	/	/				
	/	/	/	/	/	/	/	/				
	/	/	/	/	/	/	/	/				
	/	/	/	/	/	/	/	/				
	/	/	/	/	/	/	/	/				

Traffic Control

Was Traffic Control Required Today? Yes No Was WZTC according to approved TCP? Yes No

Photos/Videos taken Today? Yes No Do all Flaggers and Spotters have current flagging card? Yes No

Inspector's On Site Hours

From _____
To _____

Inspector _____

Reviewed By _____

DOT Form 422-004 EF
Revised 03/2008

Inspector's Daily Report
DOT Form 422-004 EF



Inspector's Daily Report

	IDR Sheet	of	Sheets
Contract	Day		Date

DIARY - Including but not limited to: a report of the day's operations, time log (if applicable), orders given and received, discussions with contractor, and any applicable statements for the monthly estimate.

DOTForm 422-004A EF
Revised 07/2008

Inspector

Inspector's Daily Report – Diary Page DOT Form 422-004A EF



**Washington State
Department of Transportation**

Region _____

Project Engineer _____

If Found Drop in any mail box
Return Postage Guaranteed

**Washington State Department of Transportation
P.O. Box 47300
Transportation Building
Olympia, WA 98504**

Construction Project Diary

SR _____

Section _____

F. A. No. _____

County _____ Region _____

CS _____ Contract _____

Region Administrator Project Engineer

This Diary Book from _____ to _____

Book _____ of _____

DOT Form 422-014
Revised 03/2007

Construction Project Diary
DOT Form 422-014 (Page 1 of 5)

Instructions

1. Read Chapter 10-3.6 of the Construction Manual.
2. Record all matters of Importance not covered by the routine reports or of routine matters if the circumstances are unusual, conferences with the Contractor or the Contractor's field representative, agreements made, special notes regarding equipment or organization, labor conditions, weather or other causes for delays if of any consequence, and any other matters that have a bearing on the completion of the project.
3. Start a new page for every day there is information.
4. **Stick to facts.** If an opinion is considered essential to explain project conditions, it **must** be identified as such.
5. The author of each day's entry must be identified by placing their signature or initials immediately under the last diary entry. If entries are made by more than one person, each must clearly identify the portions of the record which they have entered.
6. Subsequent entries may be made for pertinent information but must be properly identified and dated.

In the event this book is found, return to this address:

Phone No. _____

All entries must be signed or initialed; if more than one person makes entries, each must sign.

(award date)
(date of execution)
(working days)

DOT Form 422-014
Revised 03/2007

Construction Project Diary
DOT Form 422-014 (Page 2 of 5)

Variance Type	Access Type	Approval Authority	FHWA
Longitudinal Utility Installations			
Interstate median		HQ Utilities	Yes
Within full limited access		HQ Utilities	
Within partial or modified limited access highways		Region	
Medians		HQ Utilities	
Uncased Installations			
Involving transmitting material that is flammable, corrosive, expansive, energized, or unstable	Interstate		HQ Utilities
Longitudinal open trench method involving transmitting material that is flammable, corrosive, expansive, energized, or unstable	All others	Region	
NOTE: Applies to all crossings except those requiring an Access Break			
Access Breaks			
From property adjacent to freeway right of way			
	Interstate		HQ Access & Hearings
	Non-Interstate	Full Limited	HQ Access & Hearings
	All others	Region	ASDE*
Site access from freeway ramps or main line			
	Interstate		HQ Access & Hearings
	Non-Interstate	Full Limited	HQ Access & Hearings
	All others	Region	ASDE
Open Cuts of Pavement			
	Interstate		HQ Utilities
	All others	Region	Yes
Shallow Depth			
	Interstate		HQ Utilities
	All others	Region	
Scenic Class			
Overhead installations, Scenic Classes C & D		Region	
Overhead installations, Scenic Classes AX & BX, with no variances		Region	
Overhead installations scenic Classes A & B			HQ Utilities
Documents that include control zone object that comply with the 5\15 Rule (See Utilities Manual, Chapter 9, Page 27, Section 900.16)		Region	
Control Zone Location			
Location I Utility Object Variances		Region	
Location II Utility Object Reclassifications		Region	
Location III Utility Objects Aboveground Installations		Region	
Acceptance Assignment for Franchises			
Within a single region		Region	HQ Notification
For which HQ holds a Blanket Surety and the utility is in more than one region			HQ Utilities
Individual Bonds for Permits and Franchises per Utilities Manual, Chapter 1, Section 110.04			
Blanket Bonds for Permits or Franchises			HQ Utilities
General Permits		Region	

* Assistant State Design Engineer

Authority Matrix

BLANKET CROSSING AGREEMENT
 with U.S.B.R.
 State contract no. GC-1020-B
 USBR contract no. 14-06-100-2193
 (Administered by UTILITIES ENGINEER)

UNITED STATES
 DEPARTMENT OF THE INTERIOR
 BUREAU OF RECLAMATION

AGREEMENT WITH STATE OF WASHINGTON
AS TO CROSSINGS

<u>Article</u> <u>No.</u>	<u>INDEX</u>	<u>Page</u> <u>No.</u>
1	Preamble	1
2	Acquisition of Land for Project Works	1-2
3	Acquisition of Land for State Highways	2
4	Agreement for Mutual Crossing Facilities Necessary	2
5	Surfacing by State of Crossings Constructed by the United States	2-3
6	Definitions	3-4
7	Rights of Way Granted to the State	4-5
8	Rights of Way Granted to the United States	5
9	Notice of Exercise of Rights of Way	6-7
10	Cost of Crossings Initiated by State	7-8
11	Cost of Crossings Initiated by the United States	8-10
12	Constructing Crossings by the United States	10-12
13	Constructing Crossings by the State	12-13
14	Abandonment of State Structures	13
15	Abandonment of United States Structures	13-14
16	Title to and Maintenance of Crossing Facilities	14-15
17	United States Does Not Assume Liability	16
18	State Does Not Assume Liability	16
19	Right to Enter on Other's Right of Way	16-17
20	Revocations	17
21	Conditions of Labor	18-20
22	Contingent on Appropriations	20
23	Discrimination Against Employees or Applicants for Employment Prohibited	20-23
24	Domestic Preferences	23-24
25	Officials Not to Benefit	24
26	Covenant Against Contingent Fees	24-25

Contract No.
14-06-100-2193

UNITED STATES
DEPARTMENT OF THE INTERIOR
BUREAU OF RECLAMATION

AGREEMENT WITH STATE OF WASHINGTON
AS TO CROSSINGS

THIS CONTRACT, made this 14th day of June, 1961, pursuant to the Act of June 17, 1902 (32 Stat. 388) and all acts amendatory thereof or supplementary thereto, including without limitation by this enumeration the Act of August 4, 1939 (53 Stat. 1187), as amended, referred to hereinafter as the Federal Reclamation Laws, by and between THE UNITED STATES OF AMERICA (hereinafter styled the United States), acting solely through the Bureau of Reclamation and represented by the officer executing this contract, and the STATE OF WASHINGTON (hereinafter styled the State), a body politic and corporate, acting by and through its Governor, its Director of Highways (the latter being hereinafter styled the Director), and its State Highway Commission,

WITNESSETH, THAT:

2. WHEREAS, the United States is and will be engaged in the construction, reconstruction, operation and maintenance, under the Federal Reclamation Laws, within the State of Washington, of irrigation, drainage, water delivery, and reclamation projects (hereinafter called projects), and the works of the projects include and will include networks

Blanket Crossing Agreement With USBR
Page 2 of 28

of waterways and water conduits, telephone, telegraph, and electric transmission lines, and other irrigation and power works, for which the United States has acquired or will acquire lands in fee simple or rights of way of various kinds, or for which it claims rights of way under Section 90.40.050, Revised Code of Washington, the Act of Congress of August 30, 1890 (26 Stat. 391), or other acts of Congress; and

3. WHEREAS, the State now has a network of highways adjacent to and within the projects' areas and may from time to time relocate or add to these highways, and for these highways it now owns, or may hereafter acquire, lands in fee simple or rights of way of various kinds; and

4. WHEREAS, the activities of each party in and adjacent to the projects' areas will require the construction, reconstruction, modification, and operation and maintenance of mutual crossing facilities and the parties wish to avoid the burden and expense of negotiating separate contracts or arranging for and issuing franchises or permits, and to confirm by contract the understandings heretofore had with respect to crossing highway works designated or established by the State as limited access facilities; and

5. WHEREAS, the State, in most instances, desires to place on its roads the upper surfacing courses and the wearing surface whenever those are necessary in connection with the crossing of its highways by facilities of the United States under this contract, and it has been mutually

determined to be in the best interests of both parties to have the State perform such work:

NOW THEREFORE, in consideration of the grants and agreements herein contained, the parties hereto grant and agree as follows:

DEFINITIONS

6. The following terms, wherever used in this contract, shall have the following respective meanings:

"Waterway works" shall mean any canal, ditch, lateral, sublateral, drain, spillway, wasteway, siphon, pipeline, or other waterway or water conduit, and any road required in connection with the construction or operation of such works, built or to be built as part of the projects works.

"Transmission line" shall mean any telephone, telegraph, or electric transmission line or other power works, and any road required in connection with the construction or operation of such works, built or to be built as part of the projects' works.

"Project waterway" shall mean any land owned in fee or any right of way, excluding "reserved ways", designated by the United States as the site for any waterway works.

"Transmission way" shall mean any land owned in fee or any right of way, excluding "reserved ways", designated by the United States as the site for any transmission line.

"Reserved way" shall mean any right of way reserved to the United States under Section 90.40.050, Revised Code of Washington, the Act of August 30, 1890 (26 Stat. 391), or other acts of Congress, and which has been or is to be designated for use in the construction, operation and maintenance of project works as permitted by law.

"Highway works" shall mean any highway and appurtenant works built or to be built in connection with the highway system of the State.

"Highway" shall mean any land owned in fee or any right of way designated by the State as the site for its highway works.

"Project Officer" shall mean that employee of the United States in charge of a Bureau of Reclamation project in which is located a crossing to be handled pursuant to the provisions of this agreement.

"Regional Director" shall mean the Regional Director, Region 1, Bureau of Reclamation, or his duly authorized representative.

RIGHTS OF WAY GRANTED TO THE STATE

7. The United States hereby grants to the State, subject to the provisions of this contract, perpetual rights to construct, reconstruct, modify, operate and maintain highway works upon or across any project waterway, transmission way, and reserved way. The rights in each instance shall be effective from the date of the approval of the State's application made under the provisions of Article 9 hereof or provisions

similar thereto in contracts referred to in Article 20 hereof. In any instance where the grant herein made is with respect to land in which the United States has only a right of way or easement, the State will obtain any additional grants or consents from the owners of such other interests in the land as may be necessary to permit full use of the land by the State for its purposes.

RIGHTS OF WAY GRANTED TO THE UNITED STATES

8. The State hereby grants to the United States, subject to the provisions of this contract, perpetual rights to construct, reconstruct, modify, operate and maintain waterway works and transmission lines upon or across any highway, and hereby ratifies and confirms the reservation under and by virtue of the Act of August 30, 1890 (26 Stat. 391), or other acts of Congress, and Section 90.40.050, Revised Code of Washington, of the reserved way across, along, or under any highway on land subject to such reserved way. The rights in each instance shall be effective from the date of the approval of the application of the United States made under the provisions of Article 9 hereof or provisions similar thereto in contracts referred to in Article 20 hereof or from the date of any highway use franchise or permit issued by the State. In any instance where the grant herein made is with respect to land in which the State has only a right of way or easement, the United States will obtain any additional grants or consents from the owners of such interest in the land as may be necessary to permit full use of the land by the United States for its purposes.

NOTICE OF EXERCISE OF RIGHTS OF WAY

9. The party desiring to exercise the rights granted under Articles 7 and 8 shall notify the other party in writing prior to the beginning of construction. Such notice shall be given immediately before the rights are to be utilized by the construction of a crossing, and, in the case of the United States, the notice shall be given to the Project Officer, if any, otherwise the Regional Director, and, in the case of the State, to the Director. The notice shall be accompanied by a location map showing the proposed crossing and by plans for the facilities proposed to be constructed. The party receiving the notice shall promptly initiate action, including insofar as the United States is concerned consultation with the irrigation district, if any, operating its waterway works and transmission lines, on approval or disapproval of the proposed crossing, indicating in the latter instance the reasons therefor. The State will not refuse approval of reasonable plans submitted by the United States if such plans provide for a class of construction equal or superior to the standard of construction used by the State itself for similar purposes; and the United States will not refuse approval of reasonable plans submitted by the State, if such plans provide for a class of construction equal or superior to the standard of construction used by the United States for similar purposes. Approval of the plans shall be made by the execution and dating of the location map; approval of the

United States shall be given by the Regional Director; and approval of the State shall be given by the Director.

COST OF CROSSINGS INITIATED BY STATE

10. (a) Where the State's exercise of the rights granted under Article 7 has been approved under the provisions of Article 9 hereof, and at the time of that approval, waterway works or transmission lines at the point of crossings are in existence, or are being built by Government forces or are under contract to be built for the United States, the State shall, at its sole expense, construct and install whatever facilities are required and do whatever work is necessary to effect the crossing in accordance with the plans approved under Article 9 hereof. The words "are being built by Government forces", as used herein, shall not be construed to mean that which is confined solely to the clearing of rights of way and/or the building of haul or pioneer roads.

(b) Where the State's exercise of the rights granted under Article 7 has been approved under the provisions of Article 9 hereof, and at the time of that approval no waterway works or transmission lines are in existence at the point of crossing or are being built or are under contract to be built, the State, when building its highway works at the place of crossing, will (1) provide, at the request of the United States, if the latter has funds available to pay therefor, facilities necessary to accommodate the waterway works or transmission lines to be built later by the United States; or (2) construct, at the

request of the United States, if practicable, its highway works in a manner that will enable the United States, within a reasonable time after the completion thereof, to construct the facilities necessary to accommodate its waterway works or transmission lines without added undue expense or inconvenience on account thereof. The added cost to the State of providing facilities under (1) and (2) of this subarticle will be borne by the United States. In determining these costs, there shall be included all costs of materials and labor directly chargeable to the facilities as approved under subarticle (c) hereof, and in addition an amount equal to ten per cent (10%) of said costs to cover supervision, engineering, inspection, and general overhead. Promptly on the completion of the facilities in any case under (1) and (2) of this subarticle, the State shall submit to the United States an itemized bill of the added cost required to be paid by the United States hereunder. Payment of such cost shall be made promptly after the presentation of such bill.

(c) Whatever facilities are required to be constructed by the State for the United States under this article shall be constructed in accordance with plans and specifications therefor approved by the Regional Director.

COST OF CROSSINGS INITIATED BY UNITED STATES

11. (a) Where the United States' exercise of the rights granted under Article 8 has been approved under the provisions of Article 9 hereof, and at the time of that approval highway works are

in existence or are being built by State forces or are under contract to be built for the State, the United States shall, at its sole expense, construct and install whatever facilities are required and do whatever work is necessary to effect the crossing in accordance with the plans approved under Article 9 hereof. The words "are being built by State forces", as used herein, shall not be construed to mean that which is confined solely to the clearing of rights of way and/or the building of haul or pioneer roads.

(b) Where the United States' exercise of the rights granted under Article 8 has been approved under the provisions of Article 9 hereof, and at the time of that approval no highway works are in existence at the place of crossing or are being built or under contract to be built, the United States, when building its waterway works or transmission lines at the place of crossing, will (1) provide, at the request of the State, if the latter has funds available to pay therefor, facilities necessary to accommodate the highway works to be built later by the State; or (2) construct, at the request of the State, if practicable, its waterway works or transmission lines in a manner that will enable the State, within a reasonable time after the completion thereof, to construct the facilities necessary to accommodate its highway works without added undue expense or inconvenience on account thereof. The added cost to the United States of providing facilities under (1) and (2) of this subarticle will be borne by the State. In determining these costs, there shall

be included all costs of materials and labor directly chargeable to the facilities as approved under Subarticle (c) hereof, and in addition an amount equal to ten per cent (10%) of said costs to cover supervision, engineering, inspection, and general overhead. Promptly on the completion of the facilities in any case under (1) and (2) of this subarticle, the United States shall submit to the State an itemized bill of the added cost required to be paid by the State hereunder. Payment of such cost shall be made promptly after the presentation of such bill.

(c) Whatever facilities are required to be constructed by the United States for the State under this article shall be constructed in accordance with plans and specifications therefor approved by the Director.

CONSTRUCTING CROSSINGS BY UNITED STATES

12. (a) The United States, in performing work pursuant to a grant under the provisions of Article 8 of this contract, shall observe the following conditions:

(1) Such work shall be conducted in a proper and workmanlike manner;

(2) Such work shall be conducted so that the highway works will be closed to traffic for as brief a period as possible.

Upon request of the State, a suitable detour shall be constructed, at the sole cost and expense of the United States, around or over such construction so that traffic may pass freely at all times,

and such detour shall be maintained by the United States at its sole cost and expense; and

(3) The material removed from the highway shall be replaced or renewed so that, upon completion of the crossing, the highway and highway works will be in as good condition as they were prior to such work by the United States.

(b) With respect to highway surfacing work which the State desires to perform in connection with the crossing of its highways by facilities of the United States, the State will notify the Project Officer, prior to beginning such work, of its desire to perform the surfacing work. The notice shall specify the work that the State proposes to perform and shall include an itemized estimate of the cost thereof. The Project Officer shall promptly forward the notice with his recommendation to the Regional Director for approval or disapproval of the proposed work in connection with the crossing and the cost estimate therefor. The Regional Director shall indicate in case of disapproval the reasons therefor, and shall notify the representative of the State giving the notice. Upon approval of the work and estimate in behalf of the United States, the State shall furnish, lay, and finish the upper surfacing courses and the wearing surface required in connection with the crossing of its highways by facilities of the United States and shall perform all necessary work in connection therewith. The State, upon completion of the surfacing work, will submit to the United States a record of the actual costs and

expenditures incurred by the State, supported by such information as may be required by the United States, and officers of the United States shall be permitted to check the work records pertaining to any such work and all other books, accounts and records of the State to determine the correctness of the statement. Payment by the United States to the State of the portion of the cost for which the United States is liable under the terms of this subarticle, not to exceed the estimated amount approved in behalf of the United States as hereinbefore provided, shall be made after verification and approval of the cost statement by the Regional Director.

CONSTRUCTING CROSSINGS BY THE STATE

13. The State, in performing work pursuant to a grant under the provisions of Article 7 of this contract, shall observe the following conditions:

(a) Such work shall be conducted in a proper and workman-like manner.

(b) The State shall not in any case or circumstance stop, impede, or interfere with the flow of water in any waterway works, and in the event that the State performs such work during an irrigation season, which for the purpose of this contract shall ordinarily be considered to be from the 15th day of March to the 15th day of October of each year, or while the waterway works are being used for the generation of electric power, or such work is carried into an irrigation season, the State shall provide such temporary ditch,

siphon, or other structure as may be necessary and as directed and as approved by the Project Officer, to assure the continued flow of water in the waterway works along the regular course thereof without waste or loss.

(c) The material removed from the project waterway shall be replaced or renewed so that, upon completion of the work, the project waterway and waterway works will be in as good condition as they were prior to the work by the State.

ABANDONMENT OF STATE STRUCTURES

14. In the event the State abandons any of its highway works over a project waterway, the State shall, at its sole cost and expense, remove the structure or structures constructed by or for it and restore the project waterway to its condition prior to the construction of such structure or structures by or for the State, or do whatever is required by the United States to leave the project waterway in a condition satisfactory to the United States: Provided, however, That any highway works abandoned by the State and turned over to a county or municipality shall be exempt from the provisions of this article, and the United States will deal directly with the county or municipality with respect to such highway works.

ABANDONMENT OF UNITED STATES STRUCTURES

15. In the event the United States abandons any of its waterway works or transmission lines upon or across any highway, the United

States shall, at its sole cost and expense, remove the structure or structures constructed by or for it and restore the highway to its condition prior to the construction of such structure or structures by or for the United States, or do whatever is required by the State to leave the highway in a condition satisfactory to the State.

TITLE TO AND MAINTENANCE OF CROSSING FACILITIES

16. (a) Promptly upon the completion of any facilities constructed under the terms of this contract, the party doing the construction shall give written notice to the other party announcing the completion of the facilities and indicating, according to the nature and purpose thereof, which portion or portions of the facilities, hereinafter referred to as structures, shall be deemed to comprise a part of the highway works and which portion or portions shall be deemed a part of the waterway works or transmission lines. The party receiving the notice shall indicate promptly its acceptance of title as set out in the notice or its objections thereto. Such notices shall be issued and accepted on behalf of the United States by the Regional Director, and on behalf of the State by the Director.

(b) The United States and the State shall replace their respective structures at their own expense with new structures approved by the other party from time to time as the necessity arises, and make such repairs as may be necessary to protect waterway works, transmission

lines, or highway works from damage or interference from said structures. It shall be the duty of the United States and of the State in this regard to maintain their respective structures in such a manner as to be deemed safe and in repair, consistent with customary management practices.

(c) All work done by the United States or the State in maintaining or replacing their respective structures shall be done in a good workmanlike manner.

(d) In the event the United States or the State shall fail, refuse, or neglect to maintain their respective structures as in this article provided, the other party may, after thirty (30) days' written notice, replace, reconstruct, repair, or change any of said structures, forming a part of the waterway works, transmission lines, or highway works, in such manner as it shall determine: Provided, however, That in the event of an emergency, one party may, with the written assent of the owning or responsible party, perform necessary maintenance work at the expense of the party who has the obligation to pay therefor; and the party whose structures have been replaced, reconstructed, repaired, or changed shall reimburse the other party for the entire cost and expense thereof within ninety (90) days after submission of a written statement or statements showing in detail the items of expense included in the cost of the same. The party who has to pay the cost may, at its sole cost and expense, make whatever audits are necessary to verify the correctness of such statement or statements.

UNITED STATES DOES NOT ASSUME LIABILITY

17. The United States does not, by reason of this contract, or by reason of any grants made pursuant to Article 7 of this contract, assume any liability for injury or damage to any person or property incident to or arising during and in consequence of (a) the use, occupancy, and enjoyment by the State, pursuant to this contract, of any project waterway, transmission way, or reserved way; or (b) the operation and maintenance of any highway works across any project waterway, transmission way, or reserved way, pursuant to grant under Article 7 of this contract.

STATE DOES NOT ASSUME LIABILITY

18. The State does not, by reason of this contract, or by reason of any grants made pursuant to Article 8 of this contract, assume any liability for injury or damage to any person or property incident to or arising during and in consequence of (a) the use, occupancy, and enjoyment by the United States, pursuant to this contract, of any highway; or (b) the operation and maintenance of any waterway works or transmission lines across any highway pursuant to grant under Article 8 of this contract.

RIGHT TO ENTER ON OTHER'S RIGHT OF WAY

19. The United States and the State, and their respective officers, agents, contractors and employees, shall at any and all times have the right to enter upon the rights of way of the other, granted

as provided herein, for the purpose of doing anything necessary in connection with the construction, replacing, repairing, operation or maintenance of any portion or part of their respective waterway works, transmission lines, or highway works, including all structures and crossings which may be built in pursuance of the provisions of this contract, except that, as regards the State limited access highways or State highways which may, by proper act of State Legislature or by resolution of the Washington State Highway Commission, become limited access highways, the United States and its respective officers, agents, contractors and employees, shall have the right to enter upon the right of way of the State only in accordance with the plan for ingress and egress designed for such limited access highways, which plan shall include reasonable provisions to meet the needs of the United States and its operating districts in connection with the operation and maintenance of its projects.

REVOCATIONS

20. The following agreements with respect to crossings between the State and the United States and all supplements thereto are revoked and superseded by this contract:

1. Contract No. I74r-856, dated November 9, 1948, covering highway crossings in the Columbia Basin Project, Washington;

2. Contract No. I74r-1480, dated March 25, 1950, covering highway crossings in the Roza Division of the Yakima Project, Washington.

3. Contract No. 14-06-100-45, dated December 4, 1952, covering highway surfacing at waterway crossings, in the Columbia Basin Project, Washington; and

4. Contract No. 14-06-100-355, dated January 2, 1954, covering highway crossings in the Kennewick Division of the Yakima Project, Washington.

Provided, however, That any rights, privileges or grants by and between the parties thereto pursuant to the documents revoked and superseded by this article or pursuant to various franchises or permits issued to or in favor of the United States, and which are effective or in force on the date of this contract shall continue in force and effect on terms and conditions as if made under this contract.

CONDITIONS OF LABOR

21. (a) No laborer or mechanic doing any part of the work contemplated by Subarticle 10(b) of this contract on structures constituting a part of the waterway works or transmission lines of the United States, in the employ of the contractor or any subcontractor contracting for any part of said work contemplated, shall be required or

permitted to work more than eight (8) hours in any one (1) calendar day upon such work at the site thereof, except upon the condition that compensation is paid to such laborer or mechanic in accordance with the provisions of this article. The wages of every laborer and mechanic employed by the contractor or any subcontractor engaged in the performance of this contract shall be computed on a basic day rate of eight (8) hours per day, and work in excess of eight (8) hours per day is permitted only upon the condition that every such laborer or mechanic shall be compensated for all hours worked in excess of eight (8) hours per day at not less than one and one-half ($1\frac{1}{2}$) times the basic rate of pay. For each violation of the requirements of this article, a penalty of five dollars (\$5) shall be imposed upon the contractor for each laborer or mechanic for every calendar day in which such employee is required or permitted to labor more than eight (8) hours upon said work without receiving compensation computed in accordance with this article, and all penalties thus imposed shall be withheld for the use and benefit of the Government: Provided, That this stipulation shall be subject in all respects to the exceptions and provisions of UNITED STATES CODE, Title 40, Sections 321, 324, 325, 325a, and 326, relating to hours of labor and compensation for overtime.

(b) All contracts awarded by the State covering work under Sub-article 10(b) of this contract on structures constituting a part of the waterway works or transmission lines of the United States shall

contain the following provision, to wit: The contractor shall not employ any person undergoing sentence of imprisonment at hard labor.

CONTINGENT ON APPROPRIATIONS

22. The expenditure of any money or the performance of any work by the United States or the State, herein provided for, which may require appropriations of money by Congress or the Legislature or the allotment of Federal funds, shall be contingent on such appropriations or allotments being made. The failure of Congress or the Legislature to appropriate funds, or the failure of any allotment of funds, shall not, however, relieve the State or the United States from any obligation theretofore accrued under this agreement, nor give the State or the United States the right to terminate this agreement as to any of its executory features. No liability shall accrue against the United States or the State in case such funds are not so appropriated or allotted.

DISCRIMINATION AGAINST EMPLOYEES OR
APPLICANTS FOR EMPLOYMENT PROHIBITED

23. In connection with the performance of work under this contract on structures constituting a part of the waterway works or transmission lines of the United States, the State, referred to hereinafter in this article as the contractor, agrees as follows:

(a) The contractor will not discriminate against any employee or applicant for employment because of race, creed, color, or national origin. The contractor will take affirmative action to ensure that

applicants are employed, and that employees are treated during employment, without regard to their race, creed, color, or national origin. Such action shall include, but not be limited to, the following: employment, upgrading, demotion or transfer; recruitment or recruitment advertising; layoff or termination; rates of pay or other forms of compensation; and selection for training, including apprenticeship. The contractor agrees to post in conspicuous places, available to employees and applicants for employment, notices to be provided by the contracting officer setting forth the provisions of this nondiscrimination clause.

(b) The contractor will, in all solicitations or advertisements for employees placed by or on behalf of the contractor, state that all qualified applicants will receive consideration for employment without regard to race, creed, color, or national origin.

(c) The contractor will send to each labor union or representative of workers with which he has a collective bargaining agreement or other contract or understanding, a notice, to be provided by the agency contracting officer, advising the said labor union or workers' representative of the contractor's commitments under this section, and shall post copies of the notice in conspicuous places available to employees and applicants for employment.

(d) The contractor will comply with all provisions of Executive Order No. 10925 of March 6, 1961, and of the rules, regulations, and

relevant orders of the President's Committee on Equal Employment Opportunity created thereby.

(e) The contractor will furnish all information and reports required by Executive Order No. 10925 of March 6, 1961, and by the rules, regulations, and orders of the said Committee, or pursuant thereto, and will permit access to his books, records, and accounts by the contracting agency and the Committee for purposes of investigation to ascertain compliance with such rules, regulations, and orders.

(f) In the event of the contractor's noncompliance with the nondiscrimination clause of this contract or with any of the said rules, regulations, or orders, this contract may be cancelled in whole or in part and the contractor may be declared ineligible for further government contracts in accordance with procedures authorized in Executive Order No. 10925 of March 6, 1961, and such other sanctions may be imposed and remedies invoked as provided in the said Executive Order or by rule, regulation, or order of the President's Committee on Equal Employment Opportunity, or as otherwise provided by law.

(g) The contractor will include the provisions of the foregoing paragraphs (a) through (f) in every subcontract or purchase order unless exempted by rules, regulations, or orders of the President's Committee on Equal Employment Opportunity issued pursuant to Section

303 of Executive Order No. 10925 of March 6, 1961, so that such provisions will be binding upon each subcontractor or vendor. The contractor will take such action with respect to any subcontract or purchase order as the contracting agency may direct as a means of enforcing such provisions, including sanctions for noncompliance: Provided, however, That in the event the contractor becomes involved in, or is threatened with, litigation with a subcontractor or vendor as a result of such direction by the contracting agency, the contractor may request the United States to enter into such litigation to protect the interests of the United States, with the understanding that, in the event of noncompliance with the above provisions, this contract may only be cancelled under (f) thereof insofar as it relates to the State's doing work on structures constituting a part of the waterway works and transmission lines of the United States under this contract.

DOMESTIC PREFERENCES

24. In the performance of the work covered by Subarticle 10(b) of this contract on any facility constituting a part of the waterway works or transmission lines of the United States, the State, subcontractors, material men, or suppliers, shall use only such unmanufactured articles, materials, and supplies as have been mined or produced in the United States, and only such manufactured articles, materials, and supplies as have been manufactured in the United States substantially all from articles, materials, or supplies mined, produced, or manufactured,

as the case may be, in the United States. The foregoing provision shall not apply to such articles, materials, or supplies of the class or kind to be used, or such articles, materials, or supplies from which they are manufactured, as are not mined, produced, or manufactured, as the case may be, in the United States in sufficient and reasonably available commercial quantities and of a satisfactory quality, or to such articles, materials, or supplies as may be excepted by the head of the Department under the proviso of Title III, Section 3, of the Act of March 3, 1933, 47 Stat. 1520 (UNITED STATES CODE, Title 41, Section 10b).

OFFICIALS NOT TO BENEFIT

25. No Member of or Delegate to Congress, or Resident Commissioner shall be admitted to any share or part of this contract or to any benefit that may arise herefrom, but this restriction shall not be construed to extend to this contract if made with a corporation or company for its general benefit.

COVENANT AGAINST CONTINGENT FEES

26. The State warrants that no person or agency has been employed or retained to solicit or secure this instrument upon an agreement or understanding for a commission, percentage, brokerage, or contingent fee, excepting bona fide employees or bona fide established commercial agencies maintained by the State for the purpose of securing business. For breach or violation of this warranty, the

United States shall have the right to annul this instrument without liability or in its discretion to require the State to pay the full amount of such omission, percentage, brokerage, or contingent fee.

IN WITNESS WHEREOF, the parties hereto have signed their names the day and year first above written.

THE UNITED STATES OF AMERICA

By: /s/ M. B. Austin
Acting Regional Director
(Title)

STATE OF WASHINGTON

By: /s/ Albert D. Rosellini
Governor

/s/ W. A. Bugge
State Director of Highways

/s/ Ernest J. Ketcham
Washington State Highway Commission Chairman

(SEAL)

Attest:

/s/ Lorenz Goetz
Secretary

APPROVED:

/s/ John C. O'Rourke
State Attorney General

STATE OF IDAHO)
 : ss
County of Ada)

On this 14th day of June, 1961, personally

appeared before me M. B. Austin, to me known to be the official of the United States of America that executed the within and foregoing instrument and acknowledged said instrument to be the free and voluntary act and deed of said United States, for the uses and purposes therein mentioned, and on oath stated that he was authorized to execute said instrument.

IN WITNESS WHEREOF, I have hereunto set my hand and affixed my official seal the day and year first above written.

/s/ John H. Welch
Notary Public in and for the
State of Idaho
Residing at Boise

(SEAL) My commission expires: 6-10-63

- - - -

STATE OF WASHINGTON)
 : ss
County of Thurston)

On this 31st day of May, 1961, personally

appeared before me Albert D. Rosellini, to me known to be the Governor of the State of Washington that executed the within and foregoing instrument and acknowledged said instrument to be the free and voluntary act and deed of said State of Washington, for the uses and purposes therein mentioned, and on oath stated that he was authorized to execute said instrument.

IN WITNESS WHEREOF, I have hereunto set my hand and affixed my official seal the day and year first above written.

/s/ V. B. Otis
Notary Public in and for the
State of Washington
Residing at Olympia

(SEAL) My commission expires: Mch. 9, 1962

STATE OF WASHINGTON)
: ss
County of Thurston)

On this 24th day of May, 1961, personally
appeared before me Ernest J. Ketchum and

W. A. Bugge to me known to be the Chairman
of the Washington State Highway Commission and the Director of High-
ways of the State of Washington, respectively, that executed the
within and foregoing instrument and acknowledged said instrument to
be the free and voluntary act and deed of said State of Washington,
for the uses and purposes therein mentioned, and on oath stated
that they were authorized to execute said instrument.

IN WITNESS WHEREOF, I have hereunto set my hand and affixed
my official seal the day and year first above written.

/s/ V. B. Otis
Notary Public in and for the
State of Washington
Residing at Olympia

(SEAL)

My commission expires: March 9th, 1962

**NOTICE OF COMPLIANCE
CATEGORY 4 UTILITY INSTALLATION
SAME-SIDE SERVICE CONNECTION**

WSDOT _____ OFFICE _____ DATE: _____

UTILITY

UTILITY'S CONTRACTOR

Company: _____

Company: _____

Contact: _____

Contact: _____

Phone: _____

Phone: _____

Cell: _____

Cell: _____

FAX: _____

FAX: _____

LOCATION OF WORK: State Route _____ Milepost _____ Right or Left _____

CONSTRUCTION START: Date _____ Time _____

PROPOSED CONSTRUCTION:

- Buried Aerial
- Power Size: _____ (15 kv or less)
- Telephone Size: _____ (25 pair or less)
- Gas Size: _____ (1-1/4" I.D. or less)
- Gravity Sewer Size: _____ (4" I.D. or less)
- Forced Sewer Size: _____ (2" I.D. or less)
- Water Size: _____ (1" I.D. or less)
- CATV Size: _____ (1/2" O.D. or less)
- Fiber Optic Communication Size: _____ (Serves 4 or fewer residential units)

THIS INSTALLATION WILL NOT INVOLVE OPEN-CUTTING THE HIGHWAY LANES OR PAVED SHOULDER.

THIS INSTALLATION WILL ORIGINATE AT AN APPROVED FRANCHISED OR PERMITTED FACILITY.

This installation will conform to the requirements of WAC 468-34-110 and the Utilities Accommodation Policy.

Name

Authorized Signature

EXISTING FRANCHISE/PERMIT NO.: _____ **Expiration Date:** _____

SKETCH:

THIS NOTICE MAY BE **MAILED OR FAXED**
THIS NOTICE MUST BE RECEIVED BY WSDOT **24 HOURS** PRIOR TO CONSTRUCTION
WAC 468-34-110(53)(D) NOT TO BE USED IN LIMITED ACCESS CONTROLLED AREAS.

Category 4 Notice of Compliance



Utility Permit or Franchise Application
**Control Zone
 Variance Request
 Justification Questionnaire**

Permit/Franchise #:		Amendment #:	Date:
SR:	MP Limits:		
Applicant:			
Installation Description:			

INSTRUCTIONS: Answer each question thoroughly, providing detailed answers. Unanswered questions or vague, incomplete justifications will delay the review of your utility Permit or Franchise Application. (Section 4, Regional Considerations, is for Department use, and is attached as information only.)

SECTION 1 – REASON FOR VARIANCE REQUEST (to be completed by applicant)

Check those that apply:

- The state-owned operating highway right of way is not adequate to accommodate utility objects outside the Control Zone.
- Due to terrain or other features, segments of the utility facility do not warrant being located beyond the Control Zone boundary (include photos, plans, or other information supporting this claim).

SECTION 2 – VARIANCE JUSTIFICATION (to be completed by applicant)

1. Reason(s) the utility cannot be located as a Location III Object: _____
2. What makes installation of the facility outside the Control Zone limits difficult or impossible? _____
3. If cost is a factor in making installation outside the Control Zone limits unreasonable, explain why. Provide sufficient information to support justification request based on a cost impact, such as cost analyses or cost comparisons for the alternative options: _____
4. Describe the alternate routes, construction methods, and alternatives considered but rejected in favor of the current proposal: _____
5. What alternative countermeasures were considered? _____

Provide the following items to substantiate your justification request:

- Photos of area of installation.
- Roadway cross sections (from right of way to right of way, where feasible), slope areas, and terrain features.
- Illustrations of the alternative designs or routes considered.
- To illustrate efforts made to obtain easements outside of the highway right of way, include letter(s) of offer and rejection for any easement requests.

SECTION 3 – CONTROL ZONE CALCULATIONS (to be completed by applicant)

Consideration of this Variance will take place after calculations for all impacted objects have been provided. Include complete calculations showing the limits of the Control Zone and the location of each aboveground utility object within the operating highway right of way. These calculations are to be based on actual field measurements at each proposed aboveground utility location.

Basis for Control Zone Calculations

The Control Zone distance is the distance found in the Clear Zone Distance Table (see [Figure 1](#)). The Control Zone distance varies according to three factors: (1) the posted speed, (2) traffic volumes expressed as Average Daily Traffic (ADT) volumes, and (3) the highway sideslope ratio. Control Zone distance is measured in feet normal or perpendicular to the highway centerline, beginning at the edge of the traveled way (fog line) and extending outward from the highway.

Traveled Way

The portion of the roadway intended for the movement of vehicles, exclusive of shoulders and lanes for parking, turning, and storage for turning. The beginning point for measuring the Control Zone, the traveled way does not include shoulders, parking lanes, turning lanes, storage for turning lanes, bike lanes, or adjacent pedestrian paths. It is generally described as the area between the outer edge stripes (also known as fog lines).

Control Zone Conditions

The Control Zone distance is determined by using the Clear Zone Distance Table (see [Figure 1](#)) and/or the conditions (4 for cut sections and 2 for fill sections of the roadway) in the area of the aboveground utility object. For linear utility installations, the Control Zone distance may vary if any of the three factors (speed, volume, or slope) change. If so, multiple Control Zone distance calculations may be required.

Cut section with no ditch or fill section:

Condition 1: No ditch – Backslopes of 3H:1V or flatter

Condition 5: Sideslope is 4H:1V or flatter – Slope averaging, when slope varies

Condition 6: Sideslope is 3H:1V or steeper*

The Control Zone Distance is read directly from the Clear Zone Distance Table, based on the posted speed and ADT. Use the 10H:1V column when no slope is apparent at the aboveground utility object location.

Condition 2: Ditch foreslopes of 4H:1V or flatter – For all ditch backslopes, use 10H:1V cut section in calculations

The Control Zone distance is the greater of:

- The Control Zone distance for a 10H:1V cut section based on speed and ADT.
- Five feet horizontally beyond the bottom of ditch.

When a backslope steeper than 3H:1V continues for a horizontal distance of 5 feet beyond the beginning of the backslope, it is not necessary to use the 10H:1V cut slope criteria.

Condition 3: Ditch foreslope is steeper than 4H:1V – Ditch backslope is steeper than 3H:1V

The Control Zone distance is 10 feet horizontally beyond the bottom of ditch.

Condition 4: Ditch foreslope is steeper than 4H:1V, but not steeper than 3H:1V* – Ditch backslope is 3H:1V or flatter

The Control Zone distance is established using the Recovery Area Formula (see [Figure 2](#)).

*Note: The Recovery Area Formula normally applies to slopes steeper than 4H:1V, but not steeper than 3H:1V. For steeper slopes, the Recovery Area Formula may be used as a guide if the embankment height is 10 feet or less.

Clear Zone Distances for State Highways Outside Incorporated Cities*

Posted Speed (mph)	Average Daily Traffic	Cut Section (Backslope) (H:V)					Fill Section (H:V)						
		3:1	4:1	5:1	6:1	8:1	10:1	3:1	4:1	5:1	6:1	8:1	10:1
35 mph or less – Control Zone distance = 10 feet													
40	Under 250	10	10	10	10	10	10	***	13	12	11	11	10
	251-800	11	11	11	11	11	11	***	14	14	13	12	11
	801-2000	12	12	12	12	12	12	***	16	15	14	13	12
	2001-6000	14	14	14	14	14	14	***	17	17	16	15	14
	Over 6000	15	15	15	15	15	15	***	19	18	17	16	15
45	Under 250	11	11	11	11	11	11	***	16	14	13	12	11
	251-800	12	12	13	13	13	13	***	18	16	14	14	13
	801-2000	13	13	14	14	14	14	***	20	17	16	15	14
	2001-6000	15	15	16	16	16	16	***	22	19	17	17	16
	Over 6000	16	16	17	17	17	17	***	24	21	19	18	17
50	Under 250	11	12	13	13	13	13	***	19	16	15	13	13
	251-800	13	14	14	15	15	15	***	22	18	17	15	15
	801-2000	14	15	16	17	17	17	***	24	20	18	17	17
	2001-6000	16	17	17	18	18	18	***	27	22	20	18	18
	Over 6000	17	18	19	20	20	20	***	29	24	22	20	20
55	Under 250	12	14	15	16	16	17	***	25	21	19	17	17
	251-800	14	16	17	18	18	19	***	28	23	21	20	19
	801-2000	15	17	19	20	20	21	***	31	26	23	22	21
	2001-6000	17	19	21	22	22	23	***	34	29	26	24	23
	Over 6000	18	21	23	24	24	25	***	37	31	28	26	25
60	Under 250	13	16	17	18	19	19	***	30	25	23	21	20
	251-800	15	18	20	20	21	22	***	34	28	26	23	23
	801-2000	17	20	22	22	23	24	***	37	31	28	26	25
	2001-6000	18	22	24	25	26	27	***	41	34	31	29	28
	Over 6000	20	24	26	27	28	29	***	45	37	34	31	30
65	Under 250	15	18	19	20	21	21	***	33	27	25	23	22
	251-800	17	20	22	22	24	24	***	38	31	29	26	25
	801-2000	19	22	24	25	26	27	***	41	34	31	29	28
	2001-6000	20	25	27	27	29	30	***	46	37	35	32	31
	Over 6000	22	27	29	30	31	32	***	50	41	38	34	33
70	Under 250	16	19	21	21	23	23	***	36	29	27	25	24
	251-800	18	22	23	24	26	26	***	41	33	31	28	27
	801-2000	20	24	26	27	28	29	***	45	37	34	31	30
	2001-6000	22	27	29	29	31	32	***	50	40	38	34	33
	Over 6000	24	29	31	32	34	35	***	54	44	41	37	36

(In feet, from edge of traveled way**)

*This figure also applies to limited access state highways in cities and median areas on managed access state highways in cities. (See the [Design Manual](#) for guidance on managed access state highways within incorporated cities.)

**Traveled way: The portion of the roadway intended for the movement of vehicles, exclusive of shoulders and lanes for parking, turning, and storage for turning.

***When the fill section slope is steeper than 4H:1V, but not steeper than 3H:1V, the Control Zone distance is modified by the Recovery Area Formula and is referred to as the recovery area. The basic philosophy behind the Recovery Area Formula is that a vehicle can traverse these slopes but cannot recover (control steering); therefore, the horizontal distance of these slopes is added to the Control Zone distance to form the recovery area.

Clear Zone Distance Table
Figure 1

Recovery Area Formula

The Recovery Area Formula accounts for variable factors in the area adjacent to the traveled way, including shoulder width, ditch and fill slopes, speed, and traffic volumes. Use the following formula to determine the errant vehicle recovery area as defined in Section 3, Control Zone Calculations.

Recovery Area = (shoulder width) + (horizontal distance) + (Control Zone distance – shoulder width)

Where:

S = shoulder width

SD = horizontal slope distance

CZ = Control Zone distance from Control Zone Distance Table (see Figure 1)

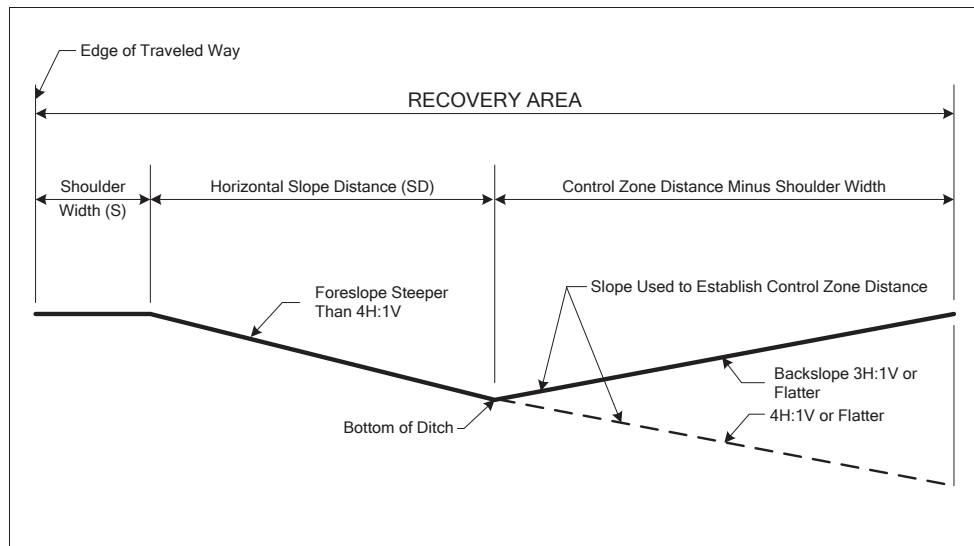

Recovery Area Elements
Figure 2

Applicant Certification and Signature

To the best of my knowledge, the information provided herein by me, employees under my supervision, or consultants hired by me is complete and accurate and factually represents all aspects of the proposed utility installation.

Signature _____

Date _____

Print name _____

Title _____

SECTION 4 – REGIONAL CONSIDERATIONS (to be completed by WSDOT)

Variance Assessment

Justification denied

Justification considered for approval

If alternatives were **not** provided and the Region is considering approval of the request, clearly document any reasons for not requiring alternative investigations and file with the application.

Background

If this is an Amendment, is the parent Franchise current (not expired)? Yes No

If it is not current, has the utility been advised that the Franchise will need to be renewed? Yes No

What is the renewal timeframe and mitigation plan, if required?

Administrative Assessment and Coordination

If a Notice of Filing is necessary, explain why:

Are the proposed location, installation methods, and embankment materials adequate to meet Department requirements?

If this utility installation will impact future design or construction of any currently programmed projects, list the projects and explain the effects of the proposed utility installation:

If there is a probability of this installation affecting currently programmed projects, (1) have appropriate design and construction offices been given an opportunity to review and comment on the proposed installation, and (2) what steps will be taken to coordinate the utility installation with affected projects?

Region Utility Office Recommendation

What is the region's recommendation regarding approval of this application?

Application Approved

Application Denied

Explain the reason(s) for approval or denial:



Utility Permit or Franchise Application
**Limited Access Encroachment
 Variance Request
 Justification Questionnaire**

Permit/Franchise #:		Date:
SR:	MP Limits:	
Applicant:		
Installation Description:		

INSTRUCTIONS: Please read each question carefully and provide thorough and complete answers in all sections. Unanswered questions or vague, incomplete justifications will delay review of your utility permit or franchise application. The WSDOT Region Utilities Office must complete Section 2, *Regional Considerations*. (It is attached for your information only.)

SECTION 1 – VARIANCE DESCRIPTION AND JUSTIFICATION (to be completed by applicant)

Part A – Conditions, Alternatives, and Preferred Route Selection

1. Reason for Installation Inside Limited Access Right of Way

Explain why it is unusually difficult or impossible to install the proposed utility outside limited access right of way:

2. Alternative Routes Considered

Identify all other route and/or installation alternatives considered, and explain why they were rejected. Attach a plan or sketch showing all routes considered:

3. Basis for Selection of Proposed Route

Explain the basis for selection of the chosen route and why it is critical to the alignment of the utility:

4. Cost Justification

If cost is a basis for justification, explain in detail what elements make the alternative locations cost-prohibitive. Attach a complete, detailed estimate of the costs.

5. Utility Maintenance

Will utility maintenance be necessary during the life of this utility? Yes No

If yes, explain the nature, frequency, duration, and management of maintenance operations, including proposed access to the utility, traffic control methods, and other aspects of maintenance operations:

6. Existing Conditions

Provide photographs showing existing conditions at the location of the proposed installation. Include vegetated areas, slope treatment, guardrail, drainage facilities, existing utilities, geologic or other natural features, and other items that will be impacted by this proposal:

7. Additional Information

Provide additional information in support of this Variance Request:

Part B – Variance Justification Submittal Requirements

All accommodation applications that include a variance proposal to occupy access controlled right of way must include:

- This Limited Access Encroachment Variance Request Justification Questionnaire.
- Plan showing all alternative routes considered.
- Engineering plans, profiles, and details for the chosen route.
- Roadway cross section of the entire right of way at regular intervals (maximum 300-foot spacing and at all changes in terrain and topography). Show details relating to width of travel lanes, turn lanes, shoulders, and widened areas, and location of existing and proposed utilities.
- Open trench cross section showing pipe and casing (if applicable), trench width, pipe zone bedding material, backfill material, and existing and replacement surfacing material, width, depth, and specification.
- Utility Maintenance Plan (if necessary).
- Cost estimate (if cost is the reason for rejection of alternatives).
- Additional supporting information.

Applicant Certification and Signature

To the best of my knowledge, the information provided herein by me, employees under my supervision, or consultants hired by me is complete and accurate and factually represents all aspects of the proposed utility installation.

Signature

Date

Print name

Title

SECTION 2 – REGIONAL CONSIDERATIONS (to be completed by WSDOT)**Background**

Is the proposed installation a Franchise Amendment? Yes No

If yes, what is the franchise number that authorizes the parent utility?

Is the parent franchise expired? If yes, process the application using the Franchise Consolidation process. Yes No

Administrative Assessment and Coordination

Is there a need for a Notice of Filing? Yes No

If yes, explain why:

Will the proposal have adverse effects on the design, construction, stability, structural integrity, maintenance, appearance, or operation of the limited access facility or its appurtenances due to the proposal? Yes No

If yes, explain the adverse effects and how their impacts will be mitigated:

Will the proposal have negative impacts or potentially adverse effects on traffic and/or pedestrian movements or on the overall operation of the limited access facility that may occur in the future due to the proposed installation? Yes No

If yes, explain the negative impacts and how they will be mitigated:

Will the utility installation affect design or construction of currently programmed projects? Yes No

If yes, list the projects and explain the effects of the proposed utility installation:

Have appropriate design and construction offices been given an opportunity to review and comment on the proposed installation? Yes No

If so, what steps will be taken to coordinate utility installation with affected projects?

Region Utility Office Recommendation

What is the region's recommendation regarding approval of this application? Application Approved
 Application Denied

Explain the reason(s) for approval or denial:



Utility Permit or Franchise Application
**Longitudinal Median Installation
 Variance Request
 Justification Questionnaire**

Permit/Franchise #:		Date:
SR:	MP Limits:	
Applicant:		
Installation Description:		

INSTRUCTIONS: Please read each question carefully and provide thorough and complete answers in all sections. Unanswered questions or vague, incomplete justifications will delay review of your utility permit or franchise application. The WSDOT Region Utilities Office must complete Section 2, *Regional Considerations*. (It is attached for your information only.)

SECTION 1 – VARIANCE IDENTIFICATION AND JUSTIFICATION (to be completed by applicant)

Part A – Conditions, Alternatives, and Preferred Route Selection

1. Reason for Installation Within Highway Median

Explain why it is unusually difficult or impossible to install the proposed utility at a location other than within the highway median:

2. Alternative Routes Considered

Identify all other route alternatives considered and explain why they were rejected. Attach a plan or sketch showing all routes considered:

3. Basis for Selection of Proposed Route

Explain the basis for selection of the chosen route and why it is critical to the alignment of the utility:

4. Cost Justification

If cost is a basis for justification, explain in detail what elements make the cost prohibitive and why. Attach a complete, detailed estimate of the costs:

5. Existing Material and Highway Appurtenances

Identify existing embankment material and roadway surfacing material adjacent to the trench and highway facilities (rock-lined ditches, guardrail or barrier, signs, other utilities, and so on) on or near the proposed open cut route:

6. Existing Conditions

Provide photographs showing existing conditions along the proposed route. Include anticipated or potential impacts to vegetated areas, geologic features, guardrail, drainage features, or other items adjacent to the open cut route.

7. Additional Information

Provide additional information in support of this Variance Request:

Part B – Variance Justification Submittal Requirements

All accommodation applications that include a variance proposal to install longitudinally in the median must include:

- This Longitudinal Median Installation Variance Request Justification Questionnaire.
- Plan showing all alternative routes considered.
- Engineering plans, profiles, and details for the chosen route.
- Roadway cross sections at regular intervals along the route of the longitudinal installation. Show details relating to width of travel lanes, turn lanes, shoulders, widened areas, drainage facilities, signing, and location of existing utilities.
- Trench cross section showing pipe and casing (if applicable); trench width; pipe zone bedding and material; backfill material; and existing and replacement surfacing material, width, depth, and specification.
- Utility Maintenance Plan (if necessary).
- Cost estimate (if cost is reason for rejection of alternatives).
- Additional supporting information.

Applicant Certification and Signature

To the best of my knowledge, the information provided herein by me, employees under my supervision, or consultants hired by me is complete and accurate and factually represents all aspects of the proposed utility installation:

Signature

Date

Print name

Title

SECTION 2 – REGIONAL CONSIDERATIONS (to be completed by WSDOT)

Background

Is the proposed installation a Franchise Amendment? Yes No
 If yes, what is the franchise number that authorizes the parent utility?

Is the parent franchise expired? If yes, process the application using the Franchise Consolidation process. Yes No

Administrative Assessment and Coordination

Is there a need for a Notice of Filing? Yes No
 If yes, explain why:

Will the proposed utility have an adverse effect on the safety, structural integrity, maintenance, appearance, or operation of the highway? Yes No
 If yes, explain why:

Is the proposed installation at a location where WSDOT agrees the proposed embankment materials and installation methods are adequate? Yes No

Will the utility installation affect design or construction of currently programmed projects? Yes No
 If yes, list the projects and explain the effects of the proposed utility installation:

Have appropriate design and construction offices been given an opportunity to review and comment on the proposed installation? Yes No
 If so, what steps will be taken to coordinate utility installation with affected projects?

Region Utility Office Recommendation

What is the region's recommendation regarding approval of this application? Application Approved
 Application Denied

Explain the reason(s) for approval or denial:

NOTICE OF FILING

Franchise Application No. _____

(Utility's name), a (private corporation, municipality, etc.), has filed with the Washington State Department of Transportation, under the provisions of Chapter 47.44 RCW and amendments thereto, an application for a franchise to construct, operate, and maintain (short description of facilities) upon a portion of State Route No. _____, in (county in which facilities are located) County, Washington, at the following locations:

(Legal description showing beginning milepost and legal description) thence northerly (easterly, etc.) to a point opposite approximate (ending milepost and legal description).

NOTICE IS HEREBY GIVEN that this franchise application may be granted by the Secretary of Transportation or his/her designee, with or without hearing, in the absence of receipt by the department of any written inquiries or objections within 14 days after posting and publishing of this notice.

DATED at (region office location), Washington, this _____ day of (Month), 20____.

Regional Administrator

Notice of Filing

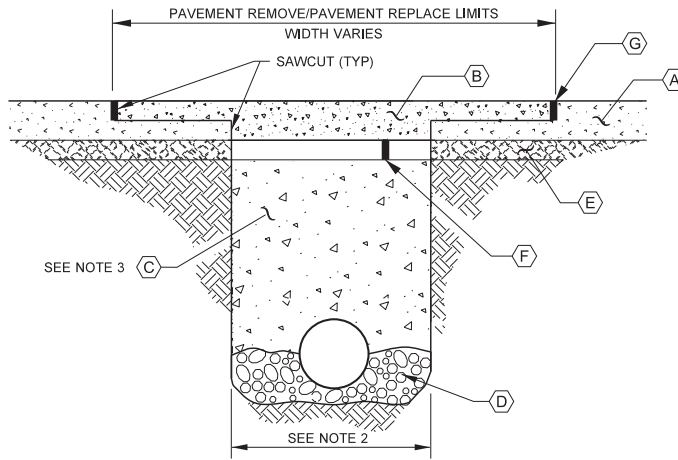

OPEN CUT CROSS SECTION
NTS

LEGEND

- (A) EXISTING HMA (HOT MIX ASPHALT) OR PCCP (PORTLAND CEMENT CONCRETE PAVEMENT).
- (B) HMA CLASS 1/2 INCH OR PCCP; DEPTH AND MATERIAL SHALL MATCH EXISTING PAVEMENT. REMOVAL AND REPLACE-
MENT LIMITS OF PAVEMENT TO BE DETERMINED AT THE TIME OF UTILITY PERMIT/FRANCHISE REVIEW.
- (C) APPROVED BACKFILL MATERIAL OR CDF (CONTROL DENSITY BACKFILL) OR AS SPECIFIED BY WSDOT.
- (D) BEDDING MATERIAL DEPTH BENEATH PIPE / CASING SHALL BE SIX (6) INCHES. ADDITIONAL PIPE BEDDING
SHALL BE PLACED EQUAL TO HALF THE DIAMETER OF PIPE / CASING OR SIX (6) INCHES WHICHEVER IS LESS.
- (E) EXISTING CRUSHED SURFACING BASE COURSE.
- (F) CRUSHED SURFACING BASE COURSE DEPTH SHALL MATCH DEPTH OF EXISTING CRUSHED
SURFACING BASE COURSE.
- (G) HMA BUTT JOINT REQUIRES TACK, SEAL AND SAND. FOR PCCP REFER TO GENERAL NOTE 5.

GENERAL NOTES

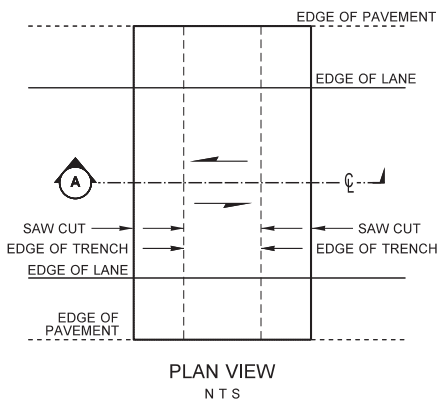

1. TRENCHING AND PIPE INSTALLATION SHALL MEET THE REQUIREMENTS OF WSDOT STANDARD SPECIFICATION 7-08.
2. MAXIMUM TRENCH WIDTH SHALL NOT EXCEED CASING / PIPE DIAMETER PLUS AN ADDITIONAL ONE (1) FOOT ON EITHER SIDE OF THE CASING / PIPE.
3. COMPACTION SHALL BE METHOD C PER STANDARD SPEC. SECTION 2-03.3 (14)C.
4. MINIMUM DEPTH SHALL BE SIXTY (60) INCHES FROM THE FINISHED SURFACE TO TOP OF CASING/ PIPE.
5. PCCP SHALL BE REPLACED TO THE NEXT PANEL JOINT IN EACH DIRECTION AS APPROVED BY WSDOT. ALL WORK SHALL BE AS SPECIFIED IN WSDOT STANDARD SPECIFICATION SECTION 5-01.3(4).
6. WHEN CONNECTING TO AN EXISTING FACILITY UNDER THE PAVEMENT, PAVEMENT RESTORATION MAY, AT THE DEPARTMENT'S DISCRETION, INCLUDE THE FULL LANE WIDTH AND ENCRoACHED SHOULDER.
7. CASING PIPES SHALL EXTEND A MINIMUM OF SIX (6) FEET BEYOND THE TOE OF FILL SLOPES, BOTTOM OF DITCHLINE, OR OUTSIDE OF CURB.
8. TACK ASPHALT PER WSDOT STANDARD SPECIFICATION 5-4.3(5)A.

APPLICATION:

APPROVALS:

REVISED: March 2012

**OPEN CUT CROSSING
UTILITY TRENCH
BACKFILL DETAIL**

DATE:

SCALE: NTS



**Washington State
Department of Transportation**
WSDOT Utility Accommodation

Sheet: of:

Open Cut Crossing Utility Trench Backfill Detail

Date _____

(applicant's name)
 XYZ Telecommunications
 1234 W. Utility Lane
 Seattle, WA 98133-9710

Subject: SR 000 CS 0000
 MP xx to MP xy
 Utility Permit/Franchise Application No. _____
Open Cut Pavement Variance Justification Request

Dear (applicant's name):

Thank you for your utility permit/franchise application. Your application to (describe installation) has been determined to be a variance from the Utilities Accommodation Policy, WAC 468-34-190(4). Specifically, you have requested to use a construction method that involves open cutting the existing paved roadway surface.

You must thoroughly justify any request to open cut the existing paved surface by explaining why an open cut construction method is the only reasonable installation alternative available for placement of your utility within the public right of way. Attached for your convenience is an Open Cut Pavement Justification Questionnaire to assist you in complying with this justification requirement.

Please complete the Open Cut Pavement Justification Questionnaire in its entirety. Unanswered questions or vague, incomplete information may cause a delay in the review.

If you need further assistance or have any questions, please call (phone number) or e-mail at (e-mail address).

Sincerely,

Name (upper/lower case)
 Title

SIGNATORY INITIALS: typist's initials

Enclosure
 cc: File

Open Cut Pavement Request Letter



Utility Permit or Franchise Application
**Open Cut Pavement
 Variance Request
 Justification Questionnaire**

Permit/Franchise #:		Date:
SR:	MP Limits:	
Applicant:		
Installation Description:		

INSTRUCTIONS: Please read each question carefully and provide thorough and complete answers in all sections. Unanswered questions or vague, incomplete justifications will delay review of your utility permit or franchise application. The WSDOT Region Utilities Office must complete Section 2, *Regional Considerations*. (It is attached for your information only.)

SECTION 1 – JUSTIFICATION OF VARIANCE PROPOSAL (to be completed by applicant)

1. Reason for Open Cut Installation

Explain why it is unusually difficult or impossible to employ subsurface (trenchless) installation techniques to install the proposed utility beneath the pavement structure:

2. Alternative Routes Considered

Identify all other route and/or installation alternatives considered, and explain why they were rejected. Attach a plan or sketch showing all routes considered:

3. Basis for Selection of Proposed Route

Explain the basis for selection of the chosen route and why it is critical to the alignment of the utility:

4. Cost Justification

If cost is a basis for justification, explain in detail what elements make the alternative locations cost-prohibitive. Attach a complete, detailed estimate of the costs.

5. Utility Maintenance

Will utility maintenance be necessary during the life of this utility? Yes No

If yes, explain the nature, frequency, duration, and management of maintenance operations, including proposed access to the utility, traffic control methods, and other aspects of maintenance operations:

6. Existing Surface Material

Identify existing surface material of traveled lanes, shoulders and widened areas, embankments, and special construction details (such as rock-lined ditch or slope treatment) at open cut location:

7. Existing Conditions

Provide photographs showing the existing conditions on both sides of highway at location of open cut. Include vegetated areas, geologic features, guardrail, drainage features, or other items that will be impacted by this open cut proposal:

8. Profile of Proposed Open Cut Installation

Provide a roadway cross section showing a profile of the proposed open cut installation across the entire WSDOT right of way at the proposed open cut location. This information should include (1) the location of all existing utilities, (2) the width of traveled lanes, turn lanes, shoulders, and widened areas outside of shoulders, and (3) the angle and depth of the proposed utility installation in relation to the existing roadway surface, ditching and/or embankments. Dimension all information from the centerline of the highway horizontally and depth information from appropriate points vertically.

9. Proposed Open Cut Trench Cross Section

Provide a proposed open cut trench cross section showing pipe and casing ID and OD (if applicable); typical trench construction width; typical pipe zone bedding depth and material; typical trench backfill depth and material; and existing and replacement surfacing depth and material and the width and method of repair of roadway surface.

10. Additional Information

Provide additional information in support of this Variance Request:

SECTION 2 – REGIONAL CONSIDERATIONS (to be completed by WSDOT)

Background

Is the proposed installation a Franchise Amendment? Yes No

If yes, what is the franchise number that authorizes the parent utility?

Is the parent franchise expired? If yes, process the application using the Franchise Consolidation process. Yes No

Administrative Assessment and Coordination

Is there a need for a Notice of Filing (WAC 468-34-030)? Yes No

If yes, explain why:

Will the proposal have adverse effects on the structural integrity, maintenance, appearance, or operation of the highway? Yes No

If yes, explain the adverse effects:

Will the proposal have negative impacts or potentially adverse effects on traffic and/or pedestrian movements or on the overall operation of the limited access facility that may occur in the future due to the proposed installation? Yes No

If yes, explain the adverse effects:

Will the utility installation affect design or construction of currently programmed projects? Yes No

If yes, list the projects and explain the effects of the utility installation:

What is the schedule of the proposed utility installation and WSDOT projects identified above and are there potential conflicts?

Have appropriate design and construction offices been given an opportunity to review and comment on the proposed installation? Yes No

If so, what steps will be taken to coordinate utility installation with affected projects?

Region Utility Office Recommendation

What is the region's recommendation regarding approval of this application? Application Approved Application Denied

Explain the reason(s) for approval or denial:

After recording return document to:

State of Washington
 Department of Transportation
 Real Estate Services Office
 P O Box 47338
 Olympia WA 98504-7338

Document Title: Quitclaim Deed

Reference Number of Related Document: { }

Grantor(s): { }

Grantee(s): State of Washington, Department of Transportation

Legal Description: { }

Additional Legal Description is on Page(s) { } of Document.

Assessor's Tax Parcel Number(s): { }

QUITCLAIM DEED

State Route { }

The Grantor, { utility company name }, { type of entity }, for and in consideration of TERMS SET FORTH IN UTILITY AGREEMENT NO. UT _____, hereby conveys and quitclaims to the **State of Washington, Department of Transportation**, the following described real property, and any after acquired interest therein, situated in { } County, State of Washington, under the imminent threat of the Grantee's exercise of its right of Eminent Domain:

For legal description and additional conditions,
 see Exhibit A attached hereto and made a part hereof.

It is understood and agreed that delivery of this deed is hereby tendered and that the terms and obligations hereof shall not become binding upon the State of Washington

RES-306
 Revised 09/05

Page { page } of { numpages } pages

FA No. F-{ } ()
 Project No. { }
 Parcel No. { }

Quitclaim Deed
Page 1 of 4

After recording return document to:

State of Washington
Department of Transportation
Real Estate Services Office
P O Box 47338
Olympia WA 98504-7338

Document Title: Quitclaim Deed
Reference Number of Related Document: { }
Grantor(s): { }
Grantee(s): State of Washington, Department of Transportation
Legal Description: { }
Additional Legal Description is on Page(s) { } of Document.
Assessor's Tax Parcel Number(s): { }

QUITCLAIM DEED

State Route { }

The Grantor, { utility company name }, { type of entity }, for and in consideration of TERMS SET FORTH IN UTILITY AGREEMENT NO. UT _____, hereby conveys and quitclaims to the **State of Washington, Department of Transportation**, the following described real property, and any after acquired interest therein, situated in { } County, State of Washington, under the imminent threat of the Grantee's exercise of its right of Eminent Domain:

For legal description and additional conditions,
see Exhibit A attached hereto and made a part hereof.

It is understood and agreed that delivery of this deed is hereby tendered and that the terms and obligations hereof shall not become binding upon the State of Washington

RES-306
Revised 09/05

Page { page } of { numpages } pages

FA No. F-{ } ()
Project No. { }
Parcel No. { }

QUITCLAIM DEED

unless and until accepted and approved hereon in writing for the State of Washington, Department of Transportation, by the Director of Real Estate Services.

Date: _____, {year}

{ utility company }

By: _____
{ officer }

Its: _____
{ name }

By: _____
{ officer }

Its: _____
{ name }

Accepted and Approved

STATE OF WASHINGTON,
Department of Transportation

By: _____
Gerald L. Gallinger
Director, Real Estate Services

Date: _____

RES-306

Page { page } of { numpages } pages Parcel No. { }

After recording return document to:

State of Washington
Department of Transportation
Real Estate Services Office
P O Box 47338
Olympia WA 98504-7338

Document Title: Quitclaim Deed
Reference Number of Related Document: { }
Grantor(s): { }
Grantee(s): State of Washington, Department of Transportation
Legal Description: { }
Additional Legal Description is on Page(s) { } of Document.
Assessor's Tax Parcel Number(s): { }

QUITCLAIM DEED

State Route { }

The Grantor, { utility company name }, { type of entity }, for and in consideration of TERMS SET FORTH IN UTILITY AGREEMENT NO. UT _____, hereby conveys and quitclaims to the **State of Washington, Department of Transportation**, the following described real property, and any after acquired interest therein, situated in { } County, State of Washington, under the imminent threat of the Grantee's exercise of its right of Eminent Domain:

For legal description and additional conditions,
see Exhibit A attached hereto and made a part hereof.

It is understood and agreed that delivery of this deed is hereby tendered and that the terms and obligations hereof shall not become binding upon the State of Washington

RES-306
Revised 09/05

Page { page } of { numpages } pages

FA No. F-{ } ()
Project No. { }
Parcel No. { }



Utility Permit or Franchise Application
**Roadway Prism Open Trench
 Variance Request
 Justification Questionnaire**

Permit/Franchise #:		Date:
SR:	MP Limits:	
Applicant:		
Installation Description:		

INSTRUCTIONS: Please read each question carefully and provide thorough and complete answers in all sections. Unanswered questions or vague, incomplete justifications will delay review of your utility permit or franchise application. The WSDOT Region Utilities Office must complete Section 2, *Regional Considerations*. (It is attached for your information only.)

SECTION 1 – VARIANCE IDENTIFICATION AND JUSTIFICATION (to be completed by applicant)

Part A – Conditions, Alternatives, and Preferred Route Selection

1. Reason for Use of Open Trench Installation Method at or Along the Chosen Route

Explain why it is unusually difficult or impossible to install the proposed utility using trenchless construction methods in lieu of open trenching the roadway prism outside the pavement structure:

2. Alternative Routes Considered

Identify all other route and/or installation alternatives considered, and explain why they were rejected. Attach a plan or sketch showing all routes considered:

3. Basis for Selection of Proposed Route

Explain the basis for selection of the chosen route and why it is critical to the alignment of the utility:

4. Cost Justification

If cost is a basis for justification, explain in detail what elements make the alternative locations cost-prohibitive. Attach a complete, detailed estimate of the costs:

5. Existing Material and Roadside Appurtenances

Identify existing embankment material and roadway surfacing material adjacent to the trench and highway facilities (such as rock-lined ditches, slope treatment, drainage facilities, vehicular barriers, signs, guideposts, mileposts, or other utilities) on or near the proposed open cut route:

6. Existing Conditions

Provide photographs showing existing conditions at the location and in the vicinity along the proposed route. Include anticipated or potential impacts to vegetated areas, geologic features, guardrail, drainage features, or other items adjacent to the open cut route:

7. Utility Maintenance

Will utility maintenance be necessary during the life of this utility? Yes No

If yes, explain the nature, frequency, duration, and management of maintenance operations, including proposed access to the utility, traffic control methods, and other aspects of maintenance operations:

8. Additional Information

Provide additional information in support of this Variance Request:

Part B – Variance Justification Submittal Requirements

All accommodation applications that include a variance proposal to use open trench construction methods within the roadway prism must include:

- This Roadway Prism Open Trench Variance Request Justification Questionnaire.
- Plan showing all alternative routes considered.
- Engineering plans, profiles, and details for the chosen route.
- Roadway cross section of the entire right of way if open cut is normal to centerline; or at regular intervals if a longitudinal open cut. Show details relating to width of travel lanes, turn lanes, shoulders, and widened areas, and location of existing and proposed utilities.
- Open trench cross section showing pipe and casing (if applicable), trench width, pipe zone bedding material, backfill material, and existing and replacement material, width, depth, and specification.
- Utility Maintenance Plan (if necessary).
- Cost estimate (if cost is reason for rejection of alternatives).
- Additional supporting information.

Applicant Certification and Signature

To the best of my knowledge, the information provided herein by me, employees under my supervision, or consultants hired by me is complete and accurate and factually represents all aspects of the proposed utility installation.

Signature

Date

Print name

Title

SECTION 2 – REGIONAL CONSIDERATIONS (to be completed by WSDOT)**Background**

Is the proposed installation a Franchise Amendment? Yes No

If yes, what is the franchise number that authorizes the parent utility?

Is the parent franchise expired? If yes, process the application using the Franchise Consolidation process. Yes No

Administrative Assessment and Coordination

Is there a need for a hearing (WAC 468-34-030)? Yes No

If yes, explain why:

Will the proposed utility have impacts or adverse effects on the design, construction, safety, stability, structural integrity, maintenance, appearance, or operation of the highway? Yes No

If yes, explain the impacts or adverse effects:

Is the proposed installation at a location where WSDOT agrees the proposed embankment materials and installation methods are adequate? Yes No

Will the proposal have negative impacts or potentially adverse effects on traffic and/or pedestrian movements or on the overall operation of the limited access facility that may occur in the future due to the proposed installation? Yes No

If yes, explain the negative impacts and how they will be mitigated:

Will the utility installation affect design or construction of currently programmed projects? Yes No

If yes, list the projects and explain the effects of the proposed utility installation:

Have appropriate design and construction offices been given an opportunity to review and comment on the proposed installation? Yes No

If so, what steps will be taken to coordinate utility installation with affected projects:

Region Utility Office Recommendation

What is the region's recommendation regarding approval of this application? Application Approved

Application Denied

Explain the reason(s) for approval or denial:



Utility Permit or Franchise Application
**Scenic Classification
 Variance Request
 Justification Questionnaire**

Permit/Franchise #:		Date:
SR:	MP Limits:	
Applicant:		Scenic Classification:
Installation Description:		

INSTRUCTIONS: As defined in WAC 468-34-330, aerial facilities along highways in Scenic Classes A and B are considered a variance from WSDOT policy and must be installed underground. Proposed installations contrary to this policy require reasonable and acceptable justification for doing so.

Please read each question carefully and provide thorough and complete answers in all sections. Unanswered questions or vague, incomplete justifications will delay review of your utility permit or franchise application. Questions requiring further clarification should be answered on a separate sheet and attached to this questionnaire. The WSDOT Region Utilities Office must complete Section 2, *Regional Considerations*. (It is attached for your information only.)

SECTION 1 – JUSTIFICATION OF VARIANCE PROPOSAL (to be completed by applicant)

1. Variance Request Description

Please explain the nature of your Variance Request and why the installation is a variance:

2. Existing Right of Way Conditions

Provide photographs showing the existing conditions and scenic vistas on both sides of highway at or along the location of the proposed installation. Include any vegetated areas, wetlands, geologic features, guardrail, drainage features, or other items that may be considered valuable to the scenic quality of this section of highway.

3. Special Exceptions Consideration

Does the proposed utility installation have power lines in excess of 35 Kv? Yes No

If yes, explain the special design features that will be incorporated into the project to minimize the visual impact of the proposed facility (if approved):

Are alternative routes or locations available for installation of the proposed utility? Yes No

If no, please explain why no alternative routes are available. Provide aerial photographs, mapping, or other evidence to support this claim:

If alternative routes are available, describe the number and location of the alternative routes considered for the proposed facility (alternative routes *must* be considered in order to obtain justification approval):

Explain why these alternative routes were not selected:

Is this facility proposed to be installed upon existing utility poles or other facilities within Class A or B? Yes No

Are the alternative locations visually more undesirable? Yes No
If yes, please explain. Support your explanation with photographic evidence and other documentation:

Is undergrounding the proposed utility technically feasible? Yes No
If no, please explain. Support your claim with geotechnical reports or similar evidence obtained during your research:

Will the cost of undergrounding adversely affect utility consumer rates? Yes No
If yes, please explain. Provide detailed calculations or analyses to support your claim:

Will the cost of undergrounding have an adverse affect on the long-term economics of the utility? Yes No
If yes, please explain. Provide detailed data supporting your claim:

4. Additional Information

Provide additional information in support of this Variance Request:

Scenic Classification Variance Request Justification Questionnaire

Page 2 of 3

SECTION 2 – REGIONAL CONSIDERATIONS (to be completed by WSDOT)

Background

Is the utility proposing to use existing utility poles as part of this installation? Yes No

If yes, who is the owner of the poles?

Are the existing poles properly franchised or permitted? Yes No

If yes, what is the permit/franchise number that permits the poles?

If a franchise, has it been renewed at least once? Yes No

If the franchise has not been renewed, is it expired? Yes No

If renewed, in what year is the current renewal due to expire?

Has the utility been informed that the franchise will need to be undergrounded at the next renewal? Yes No

If no, explain why not:

Administrative Assessment and Coordination

Is there a need for a Notice of Filing? Yes No

If yes, explain why:

Will the proposal have any adverse effects on the structural integrity, maintenance, appearance, or operation of the highway? Yes No

If yes, explain adverse effects:

Will the utility installation affect design or construction of currently programmed projects? Yes No

If yes, list the projects and explain the effects of the proposed utility installation:

Have appropriate design and construction offices been given an opportunity to review and comment on the proposed installation? Yes No

If so, what steps will be taken to coordinate utility installation with affected projects:

Region Utility Office Recommendation

What is the region's recommendation regarding approval of this application? Application Approved Application Denied

Explain the reason(s) for approval or denial:



Utility Permit or Franchise Application
**Shallow Depth Installation
 Variance Request
 Justification Questionnaire**

Permit/Franchise #:		Date:
SR:	MP Limits:	
Applicant:		
Installation Description:		

INSTRUCTIONS: Please read each question carefully and provide thorough and complete answers in all sections. Unanswered questions or vague, incomplete justifications will delay review of your utility permit or franchise application. The WSDOT Region Utilities Office must complete Section 2, *Regional Considerations*. (It is attached for your information only.)

SECTION 1 – VARIANCE IDENTIFICATION AND JUSTIFICATION (to be completed by applicant)

Part A – Conditions, Alternatives, and Preferred Route Selection

1. Reason for Shallow Depth Installation

Explain why it is unusually difficult or impossible to install the proposed utility at the minimum required depth:

2. Alternative Routes Considered

Identify all other route and/or installation alternatives considered, and explain why they were rejected. Attach a plan or sketch showing all routes considered.

3. Basis for Selection of Proposed Route

Explain the basis for selection of the chosen route and why it is critical to the alignment of the utility:

4. Cost Justification

If cost is a basis for justification, explain in detail what elements make the alternative locations cost-prohibitive. Attach a complete, detailed estimate of the costs.

5. Existing Material and Highway Appurtenances

Identify existing subgrade and embankment material and roadway surfacing material above the proposed utility installation and any highway facilities (such as rock-lined ditches, vehicular barriers, signs, guideposts, mileposts, or other utilities) on or near the shallow depth route:

6. Existing Conditions

Provide photographs showing existing conditions along the proposed route. Include any anticipated or potential impacts to vegetated areas, geologic features, guardrail, drainage features, or other items adjacent to the shallow depth route.

7. Additional Information

Provide additional information in support of this Variance Request:

Part B – Variance Justification Submittal Requirements

All accommodation applications that include a variance proposal to use open cut construction methods must include the following:

- This Shallow Depth Installation Variance Request Justification Questionnaire.
- Plan showing all alternative routes considered.
- Engineering plans, profiles, and details for the chosen route.
- Protective Measures Plan detailing protective measures installation and construction.
- Roadway cross section of the entire right of way where the shallow installation is normal to centerline, or at regular intervals if a longitudinal installation. Show details relating to width of travel lanes, turn lanes, shoulders, and widened areas, and location of existing and proposed utilities.
- Utility Maintenance Plan (if necessary).
- Cost estimate (if cost is the reason for rejection of alternatives).
- Additional supporting information.

Applicant Certification and Signature

To the best of my knowledge, the information provided herein by me, employees under my supervision, or consultants hired by me is complete and accurate and factually represents all aspects of the proposed utility installation.

Signature

Date

Print name

Title

SECTION 2 – REGIONAL CONSIDERATIONS (to be completed by WSDOT)**Background**

Is the proposed installation a Franchise Amendment? Yes No
 If yes, what is the franchise number that authorizes the parent utility?

Is the parent franchise expired? Yes No
 If yes, process the application using the Franchise Consolidation process.

Administrative Assessment and Coordination

Is there a need for a Notice of Filing? Yes No
 If yes, explain why:

Will the proposed utility have an adverse effect on the safety, structural integrity, maintenance, appearance, or operation of the highway? Yes No

Is the proposed installation at a location where WSDOT agrees the proposed embankment materials and installation methods are adequate? Yes No

Will the utility installation affect design or construction of currently programmed projects? Yes No
 If yes, list the projects and explain the effects of the proposed utility installation:

Have appropriate design and construction offices been given an opportunity to review and comment on the proposed installation? Yes No
 If so, what steps will be taken to coordinate utility installation with affected projects?

Region Utility Office Recommendation

What is the region's recommendation regarding approval of this application? Application Approved
 Application Denied

Explain the reason(s) for approval or denial:

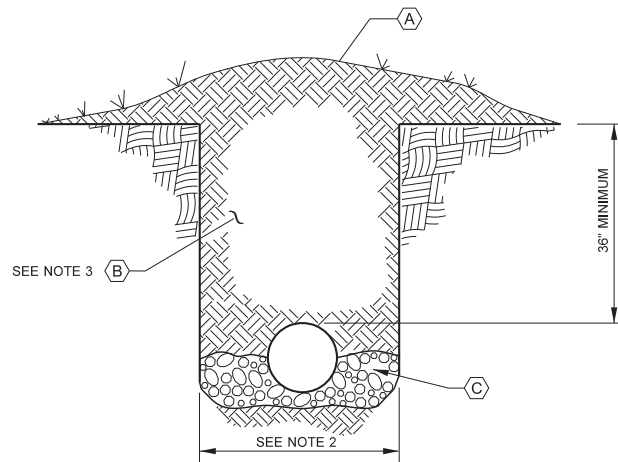

TRENCH CROSS SECTION
NTS

LEGEND

- A** SURFACE RESTORATION WILL MATCH EXISTING ADJACENT TREATMENT (SEEDING, BARK, ETC.)
- B** NATIVE MATERIAL OR AS DIRECTED BY WSDOT.
- C** BEDDING MATERIAL DEPTH BENEATH THE PIPE CASING SHALL BE SIX (6) INCHES. ADDITIONAL PIPE BEDDING SHALL BE PLACED EQUAL TO HALF THE DIAMETER OF PIPE CASING OR SIX (6) INCHES WHICHEVER IS LESS.

GENERAL NOTES

1. TRENCHING AND PIPE INSTALLATION SHALL MEET THE REQUIREMENTS OF WSDOT STANDARD SPECIFICATION 7-08
2. MAXIMUM TRENCH WIDTH SHALL NOT EXCEED THE CASING / PIPE DIAMETER PLUS AN ADDITIONAL ONE FOOT ON EITHER SIDE OF THE CASING / PIPE.
3. COMPACTION SHALL BE METHOD C PER SECTION 2-03.3 (14)C
4. CASING PIPES SHALL EXTEND A MINIMUM OF SIX (6) FEET BEYOND THE TOE OF FILL SLOPES, BOTTOM OF DITCHLINE, OR OUTSIDE OF CURB.

APPLICATION:	UTILITY TRENCH BACKFILL DETAIL	 Washington State Department of Transportation WSDOT Utility Accommodation	
APPROVALS:			
REVISD: March 2012			DATE:

Utility Trench Backfill Detail

