

[1600.01 General](#)

[1600.02 Clear Zone](#)

[1600.03 Mitigation Guidance](#)

[1600.04 Medians](#)

[1600.05 Other Roadside Safety Features](#)

[1600.06 References](#)

[Exhibit 1600-1 Clear Zone Plan View](#)

[Exhibit 1600-2 City and State Responsibilities and Jurisdictions](#)

[Exhibit 1600-3 Design Clear Zone Distance Table](#)

[Exhibit 1600-4 Recovery Area](#)

[Exhibit 1600-5 Design Clear Zone Examples for Ditch Sections: 3 Cases](#)

[Exhibit 1600-6 Requirements for Embankment Mitigation](#)

[Exhibit 1600-7 Mailbox Location and Turnout Design](#)

[Exhibit 1600-8 Glare Screens](#)

## 1600.01 General

Roadside safety addresses the area outside the roadway and is an important component of total highway design. There are numerous reasons why a vehicle leaves the roadway, including driver error and behaviors. Regardless of the reason, a roadside design can reduce the severity and subsequent consequences of a roadside encroachment. From a crash reduction and severity perspective, the ideal highway has roadsides and median areas that are relatively flat and unobstructed by objects. It is also recognized that different facilities have different needs and considerations, and these issues are considered in any final design.

It is not possible to provide a clear zone free of objects at all locations and under all circumstances. The engineer faces many tradeoffs in design decision-making such as balancing needs of the environment, right of way, and various modes of transportation. The fact that recommended design values related to the installation of barrier and other mitigation countermeasures are presented in this chapter, does not mean that WSDOT is required to modify or upgrade existing locations to meet current criteria.

Roadside safety may be addressed by projects identified through priority programming, during certain preservation project activities (See [Chapter 1120](#)), or may be considered by projects as part of a safety analysis (See [Chapter 321](#)). Elements such as sideslopes, fixed objects, and water are all features that a vehicle might encounter when it leaves the roadway and become part of such an analysis. Roadside safety devices, such as traffic barriers, bridge barriers, transitions, impact attenuators, and breakaway devices, are features that may be installed to mitigate a specific roadside condition.

On projects where the need to mitigate objects is determined based on location related to Design Clear Zone, consider the following mitigation measures in this order: (See Section [1600.02](#) Clear Zone)

1. Remove
2. Relocate
3. Redesign a fixed object by using breakaway features or making the fixed object traversable (See Section [1600.03](#))
4. Shield with a traffic barrier
5. Delineate (To only delineate requires a Design Analysis. If this seems to be your only option, consult your Region Traffic Barrier Expert or your Region's ASDE.)

Factors for selecting a mitigation measure include, but may not be limited to:

- Crash severity potential
- Maintenance needs
- Cost (initial and life cycle costs)

Rumble strips can be employed to reduce the potential for lane departure or roadside encroachment in certain contexts (see Section [1600.05\(1\)](#)). Use traffic barriers when other measures cannot reasonably be accomplished, and conditions are appropriate based on an engineering analysis (See [Chapter 1610](#)).

### 1600.02 Clear Zone

A clear roadside border area beginning at the edge of the traveled way is a primary consideration with existing or new roadside and median features (see Section 1600.03). The intent is to provide a clear, traversable area for a vehicle driver or bicyclist to recover when their path is altered due to environmental, human, or vehicle or bicycle factors.

The Design Clear Zone indicates the target value for the clear roadside area (clear zone) and the level of documentation associated with roadside design. When a project will be addressing clear zone (see Exhibit 1105-1), compile an inventory of roadside and median features when they are located entirely or partially inside the Design Clear Zone, whether they are existing or proposed by the project. Document each inventoried feature location, the corrective actions considered, estimated cost to correct, and if the correction is planned or not using the [Design Clear Zone Inventory Form](#). In cases where no action is taken, provide the reason(s) on the back of the form.

In situations where the Design Clear Zone is beyond WSDOT right of way, evaluate options on a case-by-case basis. Consider the nature of the objects within the Design Clear Zone, the roadway geometry, traffic volume, and crash history. Coordinate with adjacent property owners when proposed options include any work beyond WSDOT right of way. At a minimum, provide clear zone to the limits of the WSDOT right of way.

Clear zone is measured from the edge of the through traveled way, representing the intended lane of travel by any and all vehicles using the facility, and in both directions of travel on two-way facilities (see Exhibit 1600-1). All projects that alter the relationship between the through lane and the roadside by widening or realignment have altered the existing clear zone and require an evaluation of objects in the clear zone. Design Clear Zone principles apply to an auxiliary lane that operates as a through lane (such as a passing lane, truck climbing lane, etc.) while excluding turn lanes for at-grade intersections from applying Design Clear Zone principles.

#### Exhibit 1600-1 Clear Zone Plan View

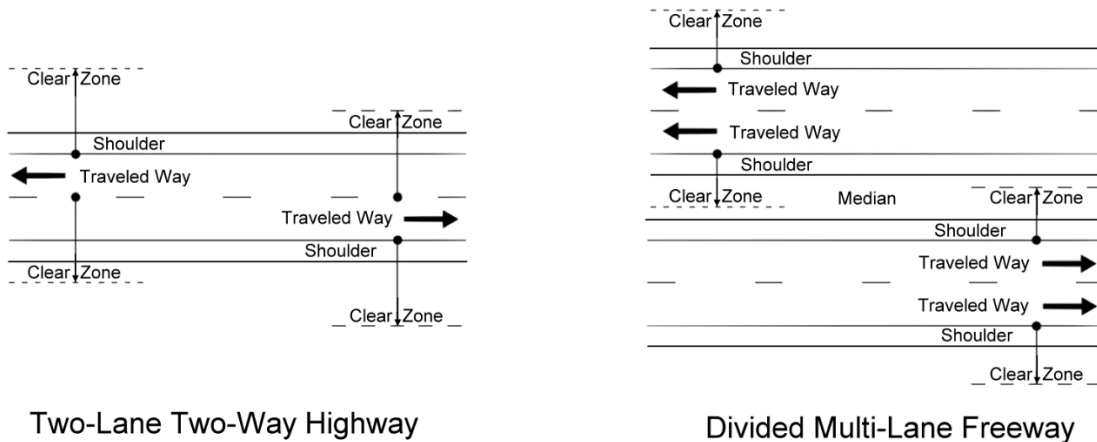

### 1600.02(1) Design Clear Zone along Limited Access State Highways and Other State Highways Outside Incorporated Cities and Towns

Use the Design [Clear Zone Inventory form](#) to identify features to be mitigated and propose actions taken to address those features.

Guidance for establishing the Design Clear Zone for highways outside incorporated cities is provided in [Exhibit 1600-3](#). This guidance also applies to limited access facilities within the city limits. Providing a clear recovery area that is consistent with this guidance does not require any additional documentation. However, there might be situations where it is not practicable to provide these recommended distances. In these situations, document the decision as a Design Analysis as discussed in [Chapter 300](#).

There is flexibility in establishing the Design Clear Zone in urbanized or urbanizing areas where operating speeds are 35 mph or less. To achieve this flexibility, use a Design Analysis to establish the Design Clear Zone that presents the tradeoffs associated with the decision. Provide information on the benefits and effects of the Design Clear Zone selected in the Design Analysis, including safety, aesthetics, the environment, economics, modal needs, and access control. Although not a WSDOT policy document on clear zone, Chapter 10 of the *AASHTO Roadside Design Guide* provides information to consider when performing a Design Analysis in urbanized areas.

In curbed sections, and where applicable (e.g., parking), provide an 18-inch operational offset beyond the face of curb for lateral clearance to accommodate opening car doors or large side mirrors.

### 1600.02(2) Design Clear Zone Inside Incorporated Cities and Towns

For managed access state highways within an urban area, it might not be practicable or appropriate to provide the Design Clear Zone distances shown in [Exhibit 1600-3](#). Roadways within an urban area generally have curbs and sidewalks and might have objects such as trees, poles, benches, trash cans, landscaping, and transit shelters along the roadside.

For projects on city streets as state highways that include work in those areas that are the city's responsibility and jurisdiction (see [Exhibit 1600-2](#)), design the project using the city's development/design standards.

The standards adopted by the city must meet the requirements set by the City Design Standards Committee for all arterial projects, bike projects, and federal-aid projects. See the [Local Agency Guidelines](#), Chapter 42, for more information on this Committee.

#### Exhibit 1600-2 City and State Responsibilities and Jurisdictions

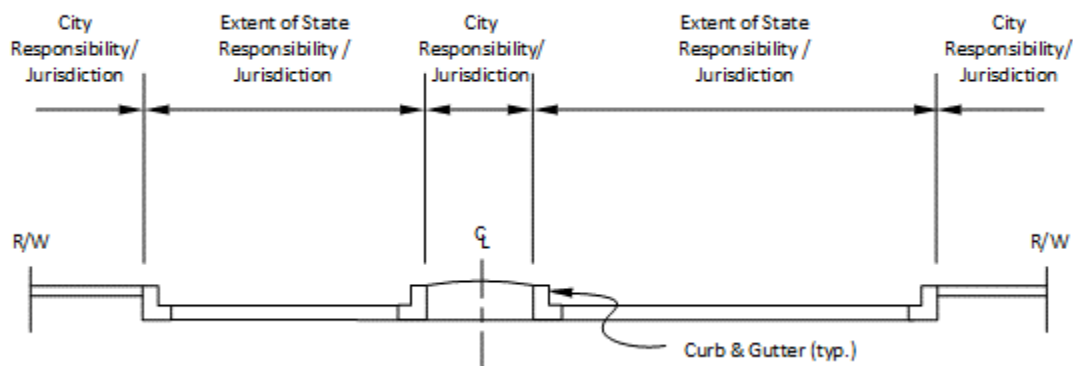

Roadway with Raised Median (Landscaped)

### 1600.02(2)(a) Roadside and Median

For managed access state highways inside incorporated cities, it is the city's responsibility to establish an appropriate Design Clear Zone in accordance with guidance contained in the City and County Design Standards (*Local Agency Guidelines*, Chapter 42.) [Exhibit 1600-2](#) shows an example of state and city responsibilities and jurisdictions. Document the Design Clear Zone established by the city in the Design Documentation Package. Have the responsible transportation official from the city (e.g., City Engineer) document the Design Clear Zone, and their acknowledgement and acceptance of the design and maintenance responsibilities for project roadides and medians, in a letter addressed to WSDOT, and file this letter as part of the local agency coordination in the Design Documentation Package. Respond to the sender acknowledging receipt.

### 1600.02(3) Design Clear Zone and Calculations

Use [Exhibit 1600-3](#) to determine the Design Clear Zone based on posted speed, sideslopes, and traffic volume at any given location. Note that there are no Design Clear Zone distances in the table for 3H:1V fill slopes. Fill slopes steeper than 4H:1V, but not steeper than 3H:1V are considered traversable if free of fixed objects. However, these slopes are also defined as nonrecoverable slopes. On nonrecoverable slopes, a vehicle might be able to begin recovery on the shoulder but will be unable to further recover control until it reaches a flatter area (4H:1V or flatter fill slope/3H:1V or flatter cut slope) beyond the toe of the nonrecoverable slope. Under these conditions, the Design Clear Zone distance is called a recovery area. The method used to calculate the recovery area and an example are shown in [Exhibit 1600-4](#).

For ditch sections, the following criteria determine the Design Clear Zone:

- a) For ditch sections with foreslopes 4H:1V or flatter (see [Exhibit 1600-5](#), Case 1, for an example), the Design Clear Zone distance is the greater of the following:
  - The Design Clear Zone distance for a 10H:1V cut section based on speed and the average daily traffic (ADT); or
  - A horizontal distance of 5 feet beyond the beginning of the backslope.
- b) For ditch sections with foreslopes steeper than 4H:1V and backslopes steeper than 3H:1V, the Design Clear Zone distance is 10 feet horizontal beyond the beginning of the backslope (see [Exhibit 1600-5](#), Case 2, for an example).
- c) For ditch sections with foreslopes steeper than 4H:1V and backslopes 3H:1V or flatter, the Design Clear Zone distance is the distance established using the recovery area formula (see [Exhibit 1600-4](#); also see [Exhibit 1600-5](#), Case 3, for an example).

## Exhibit 1600-3 Design Clear Zone Distance Table

This exhibit applies to all state highways outside incorporated cities and Limited access state highways within cities.

Posted Speed (mph)	Average Daily Traffic	Cut Section (Backslope) (H:V)						Fill Section (H:V)					
		3:1	4:1	5:1	6:1	8:1	10:1	3:1	4:1	5:1	6:1	8:1	10:1
35 or Less		The Design Clear Zone Distance is 10 ft											
40	Under 250	10	10	10	10	10	10	*	13	12	11	11	10
	251 – 800	11	11	11	11	11	11	*	14	14	13	12	11
	801 – 2,000	12	12	12	12	12	12	*	16	15	14	13	12
	2,001 – 6,000	14	14	14	14	14	14	*	17	17	16	15	14
	Over 6,000	15	15	15	15	15	15	*	19	18	17	16	15
45	Under 250	11	11	11	11	11	11	*	16	14	13	12	11
	251 – 800	12	12	13	13	13	13	*	18	16	14	14	13
	801 – 2,000	13	13	14	14	14	14	*	20	17	16	15	14
	2,001 – 6,000	15	15	16	16	16	16	*	22	19	17	17	16
	Over 6,000	16	16	17	17	17	17	*	24	21	19	18	17
50	Under 250	11	12	13	13	13	13	*	19	16	15	13	13
	251 – 800	13	14	14	15	15	15	*	22	18	17	15	15
	801 – 2,000	14	15	16	17	17	17	*	24	20	18	17	17
	2,001 – 6,000	16	17	17	18	18	18	*	27	22	20	18	18
	Over 6,000	17	18	19	20	20	20	*	29	24	22	20	20
55	Under 250	12	14	15	16	16	17	*	25	21	19	17	17
	251 – 800	14	16	17	18	18	19	*	28	23	21	20	19
	801 – 2,000	15	17	19	20	20	21	*	31	26	23	22	21
	2,001 – 6,000	17	19	21	22	22	23	*	34	29	26	24	23
	Over 6,000	18	21	23	24	24	25	*	37	31	28	26	25
60	Under 250	13	16	17	18	19	19	*	30	25	23	21	20
	251 – 800	15	18	20	20	21	22	*	34	28	26	23	23
	801 – 2,000	17	20	22	22	23	24	*	37	31	28	26	25
	2,001 – 6,000	18	22	24	25	26	27	*	41	34	31	29	28
	Over 6,000	20	24	26	27	28	29	*	45	37	34	31	30
65	Under 250	15	18	19	20	21	21	*	33	27	25	23	22
	251 – 800	17	20	22	22	24	24	*	38	31	29	26	25
	801 – 2,000	19	22	24	25	26	27	*	41	34	31	29	28
	2,001 – 6,000	20	25	27	27	29	30	*	46	37	35	32	31
	Over 6,000	22	27	29	30	31	32	*	50	41	38	34	33
70	Under 250	16	19	21	21	23	23	*	36	29	27	25	24
	251 – 800	18	22	23	24	26	26	*	41	33	31	28	27
	801 – 2,000	20	24	26	27	28	29	*	45	37	34	31	30
	2,001 – 6,000	22	27	29	29	31	32	*	50	40	38	34	33
	Over 6,000	24	29	31	32	34	35	*	54	44	41	37	36

\*When the fill section slope is steeper than 4H:1V, but not steeper than 3H:1V, the Design Clear Zone distance is modified by the recovery area formula (see [Exhibit 1600-4](#)) and is referred to as the recovery area. The basic philosophy behind the recovery area formula is that the vehicle can traverse these slopes but cannot recover (control steering); therefore, the horizontal distance of these slopes is added to the Design Clear Zone distance to form the recovery area. Provide a minimum of 10 feet at the toe of all traversable, non-recoverable fill slopes.

## Notes:

For Roadside and Median areas on managed access state highways within incorporated cities, see Section [1600.02](#) for guidance. Curb is not considered adequate to redirect an errant vehicle.

Design Clear Zone distances are given in feet, measured from the edge of traveled way.

**Exhibit 1600-4 Recovery Area**

**Recovery area formula** = (shoulder width) + (nonrecoverable slope distance) + the greater of [10 ft or (Design Clear Zone distance – shoulder width)]

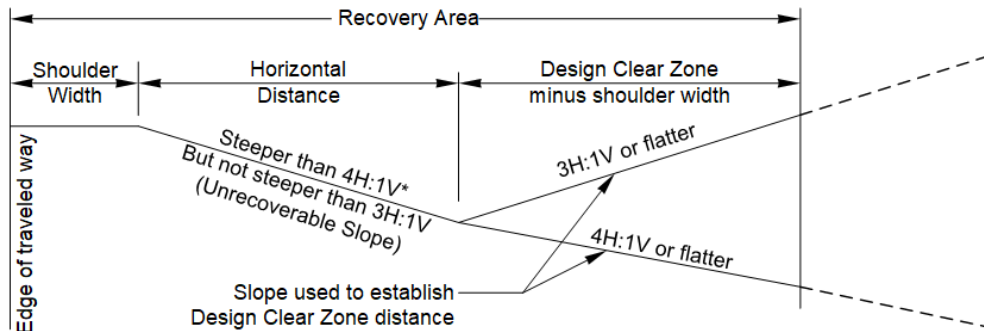

\* When the fill section slope is steeper than 4H:1V, but not steeper than 3H:1V, the Design Clear Zone distance is modified by the recovery area formula (see Exhibit 1600-4) and is referred to as the recovery area. The recovery area formula can be used in certain situations with foreslopes steeper than 3H:1V (see Section 1600.03(1)(a) and Exhibit 1600-5: Case 3 for more information). The basic philosophy behind the recovery area formula is that the vehicle can traverse these slopes but cannot recover and return to the roadway (control steering); therefore, the horizontal distance of these slopes is added to the Design Clear Zone distance to form the recovery area.

**Example Recovery Area Calculation**

3H:1V foreslope with 6H:1V fill section used to establish Design Clear Zone distance

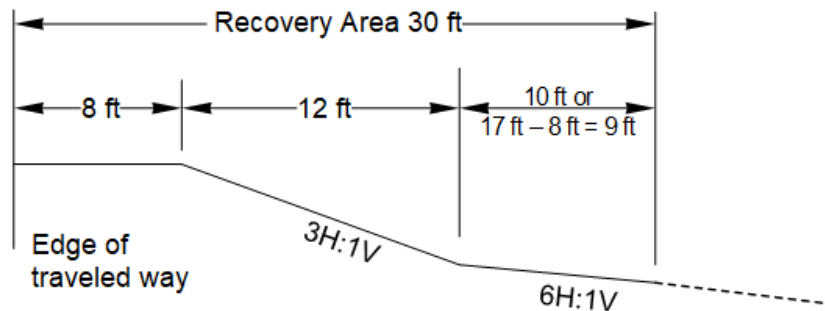

**Example Conditions**

- Speed = 45 mph
- Traffic = 3,000 ADT
- Foreslope 1 = 3H:1V (non-recoverable)
- Foreslope 2 = 6H:1V (traversable)

**Design Clear Zone Distance Criteria**

The fill section foreslope is non-recoverable (slope is steeper than 4H:1V, but not steeper than 3H:1V).  
Use the recovery area formula.

**Example Recovery Area Calculations**

Recovery area formula = (shoulder width) + (nonrecoverable slope distance) + (the greater of [1] or [2])

- [1] 10-ft
- OR

[2] Design Clear Zone distance of traversable slope (Exhibit 1600-3, 6H:1V fill section) – shoulder width = 17-ft – 8-ft = 9-ft

Recovery Area = 8-ft + 12-ft + 10-ft = 30-feet

## Exhibit 1600-5 Design Clear Zone Examples for Ditch Sections: 3 Cases

## Case 1: Cut Section with Ditch (foreslope 4H:1V or flatter)

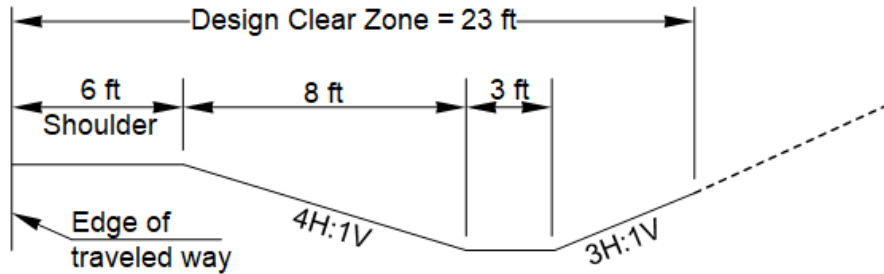
**Example Conditions**

Speed = 55 mph

Traffic = 4,200 ADT

Foreslope = 4H:1V

**Design Clear Zone Distance Criteria**

The cut section with ditch foreslope is 4:1 or flatter. For the Design Clear Zone distance, use the greater of:

- [1] Design Clear Zone distance for 10H:1V Cut Section (see [Exhibit 1600-3](#))
- OR
- [2] 5-foot horizontal distance beyond beginning of backslope

**Example Design Clear Zone Distance Calculations**

- [1] Design Clear Zone distance = Design Clear Zone distance for 10H:1V Cut Section = 23-ft
  - OR
  - [2] Design Clear Zone Distance = Beginning of backslope + 5-ft Design Clear Zone Distance = (6-ft + 8-ft + 3-ft) + 5-ft = 22-ft
- Design Clear Zone = 23-feet

## Case 2: Cut section with ditch (foreslope steeper than 4H:1V and backslope steeper than 3H:1V)

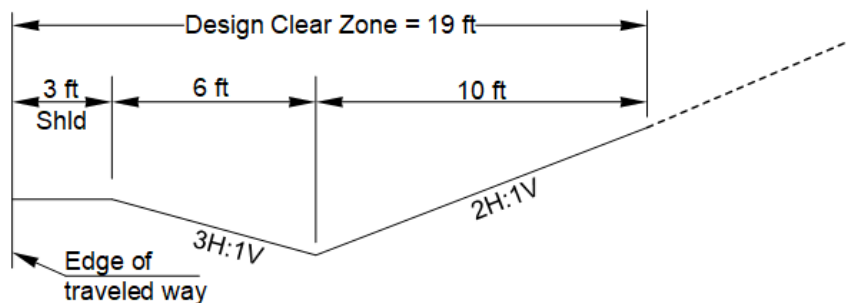
**Example Conditions**

Foreslope = 3H:1V

Backslope = 2H:1V

Beginning of backslope = 9-ft

**Design Clear Zone Distance Criteria**

The cut section with ditch foreslope is steeper than 4:1, and the ditch backslope is steeper than 3:1. The Design Clear Zone distance is 10-feet beyond the beginning of the ditch backslope.

**Example Design Clear Zone Distance Calculations**

Design Clear Zone Distance = (Beginning of backslope) + 10-ft  
 Design Clear Zone Distance = (3-ft + 6-ft) + 10-ft = 19-ft  
 Design Clear Zone = 19-feet

**Case 3:** Cut section with ditch (foreslope steeper than 4H:1V and backslope 3H:1V or flatter)

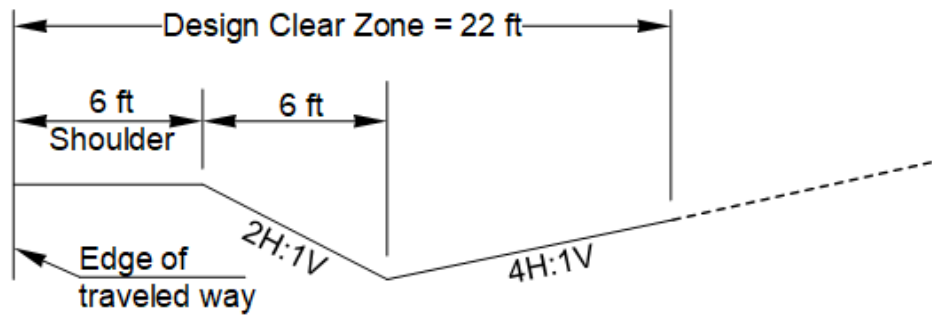

#### Example Conditions

Speed = 45 mph  
 Traffic = 3,000 ADT  
 Foreslope = 2H:1V  
 Backslope = 4H:1V

#### Design Clear Zone Distance Criteria

The cut section with ditch foreslope that is either:

- (A) a non-recoverable slope (steeper than 4:1 but not steeper than 3:1)  
OR
- (B) a critical slope (steeper than 3:1) less than 10-foot high (see Section [1600.03\(1\)\(a\)](#))

and the ditch backslope is 3H:1V or flatter.

Use recovery area formula ([Exhibit 1600-4](#)).

#### Example Recovery Area Calculations

Recovery Area = (shoulder width) + (non-recoverable or critical slope horizontal distance) + (greater of [1] or [2]):

[1] 10-ft

OR

[2] Design Clear Zone distance of 4H:1V backslope (see [Exhibit 1600-3](#); 4H:1V Cut Section) - shoulder width = 15-ft - 6-ft = 9-ft

Recovery Area = 6-ft + 6-ft + 10-ft = 22-feet



### 1600.03 Mitigation Guidance

There are three general categories of features to be mitigated: sideslopes, fixed objects, and water. This section provides guidance for determining when these objects are to be mitigated. For each case, the following conditions need consideration:

- Locations with an expected elevated crash frequency.
- Locations with pedestrian and bicyclist usage (See [Chapter 1510](#), Pedestrian Facilities, [Chapter 1515](#), Shared-Use Paths, and [Chapter 1520](#), Roadway Bicycle Facilities).
- Locations where speed management measures are present or contemplated (See [Chapter 1103](#)).
- Locations with playgrounds, monuments, and other locations with high social value.
- Locations where redirection landforms, also referred to as earth berms, were installed to mitigate objects located in depressed medians and at roadsides. They were constructed of materials that provided support for a traversing vehicle. With slopes in the range of 2H:1V to 3H:1V, they were intended to redirect errant vehicles. The use of redirection landforms has been discontinued as a means for mitigating fixed objects. Where redirection landforms currently exist as mitigation for a fixed object, provide designs where the landforms, and the feature(s) they were intended to mitigate, are removed, relocated, made crashworthy, or shielded with barrier.

The use of a traffic barrier for mitigation of features other than those described in the section below requires justification.

#### 1600.03(1) Side Slopes

##### 1600.03(1)(a) Fill Slopes

Fill slopes can increase the crash potential for an errant vehicle with the degree of severity dependent upon the slope and height of the fill. Providing fill slopes that are 4H:1V or flatter can mitigate this condition. If flattening the slope is not feasible or cost-effective, the installation of a barrier might be appropriate. [Exhibit 1600-6](#) represents a selection procedure used to determine whether a fill sideslope constitutes a condition for which a barrier is a cost-effective mitigation. The curves shown on [Exhibit 1600-6](#) are based on the severity indexes and represent the points where total costs associated with a traffic barrier are equal to the predicted cost of crashes over the service life for selected slope heights without traffic barrier.

Using [Exhibit 1600-6](#), if the ADT and height of fill intersect below the “Slope Mitigation Required” side of the given embankment slope curve, then flatten the slope. Otherwise, provide a barrier if flattening the slope is not feasible.

In new construction or reconstruction, a design analysis is required when not flattening slopes nor installing barrier in instances where [Exhibit 1600-6](#) indicates that mitigation is required, or when installing barrier in instances where [Exhibit 1600-6](#) indicates mitigation is not required.

Do not use [Exhibit 1600-6](#) for fill slope design. First, design slopes following guidance in [Chapter 1239](#) by evaluating side slope designs with clear, traversable slopes before pursuing a barrier option. Then, use [Exhibit 1600-6](#) to verify whether slope flattening or barrier is required for the slope.

Exhibit 1600-6 Requirements for Embankment Mitigation

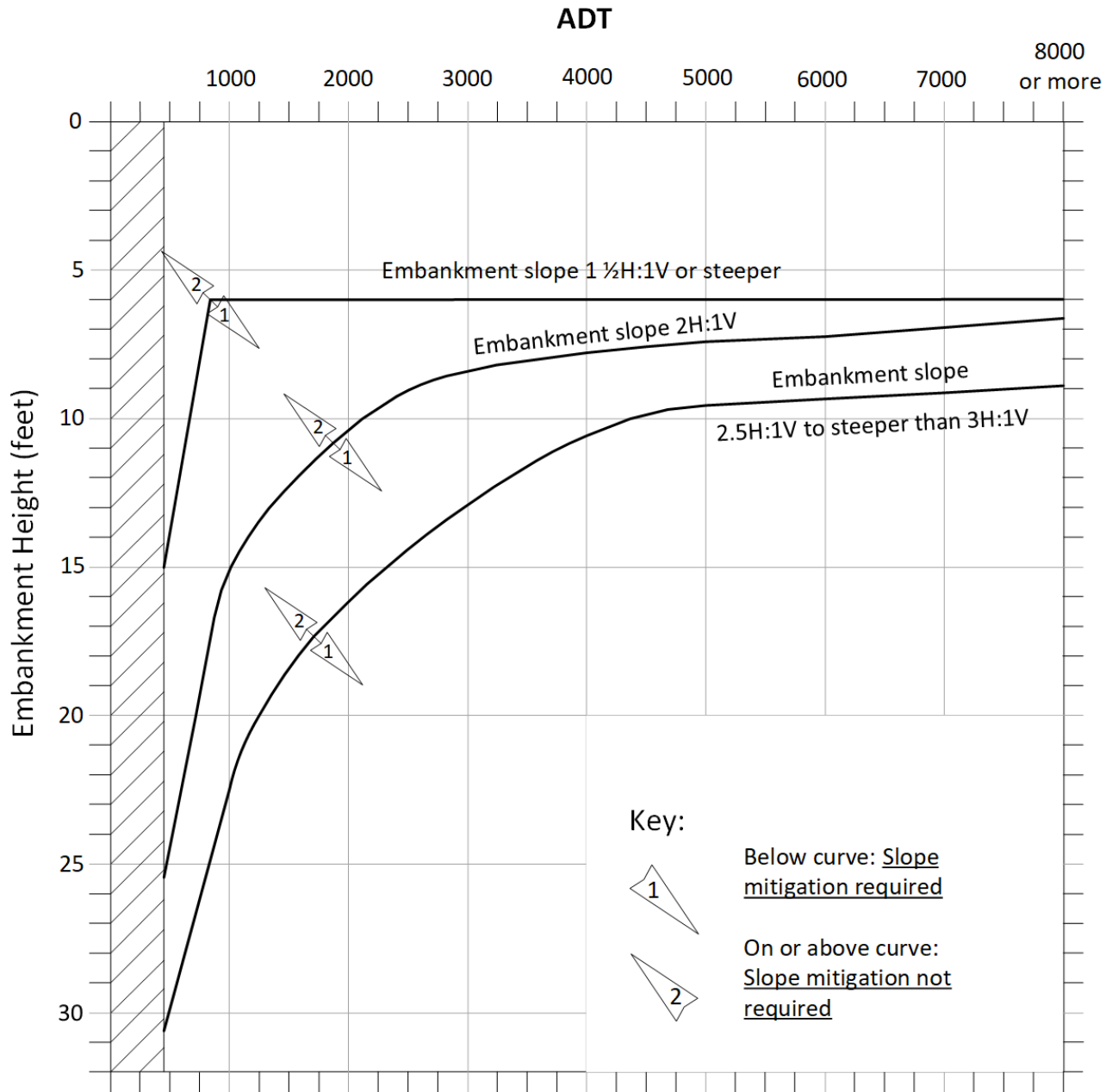

Notes:

Routes with ADTs under 400 may be evaluated on a case-by-case basis.

See Section [1600.03\(1\)\(a\)](#) for slope mitigation guidance.

### 1600.03(1)(b) Cut Slopes

A traversable cut slope reduces crash potential. The exception is a rock cut with a rough face that might cause vehicle snagging rather than providing relatively smooth redirection.

Analyze the location and evaluate the roadside characteristics, crash potential, and other benefits of treatment of rough rock cuts located within the Design Clear Zone. Conduct an individual investigation for each rock cut or group of rock cuts.

A cost-effectiveness analysis that considers the consequences of doing nothing, removal, smoothing of the cut slope, grading at the base of the rock cut to provide a smooth surface, and other viable options to reduce the severity of the condition can be used to determine the appropriate treatment. Some potential mitigative options are roadside barrier and rumble strips.

### 1600.03(2) Fixed Objects

Use engineering judgment when considering the following objects for mitigation:

- Wooden poles or posts with cross-sectional areas greater than 16 square inches that do not have breakaway features.
- Signs, illumination, cameras, weather stations, and other items mounted on non-breakaway poles, cantilevers, or bridges.
- Trees with a diameter of 4 inches or more, measured at 6 inches above the ground surface.
- Fixed objects extending above the ground surface by more than 4 inches; for example, boulders, concrete bridge rails, signal/electrical/ITS cabinets, piers, and retaining walls.
- Drainage elements, such as culvert and pipe ends.

### 1600.03(2)(a) Trees

When evaluating new plantings or existing trees in the Design Clear Zone, consider the maximum allowable diameter of 4 inches, measured at 6 inches above the ground when the tree has matured. When removing trees within the Design Clear Zone, complete removal of stumps is preferred. However, to avoid significant disturbance of the roadside vegetation, larger stumps may be mitigated by grinding or cutting them flush to the ground and grading around them.

Removal of trees may reduce the severity of impacts of roadway departure. It is recognized that different facilities have different needs and considerations, and these issues are considered in any design. For instance, removal of trees within the Design Clear Zone may not be desirable in suburban, urban, or urban core areas, or in other land use contexts that provide for non-motorized uses, such as a forest, park, or within a scenic and recreational highway. In these situations, analyze crash reports' contributing factors to determine whether roadside vegetation is contributing to the severity of crashes. If large vegetation is removed, consult guidance contained in established vegetation management plans, corridor plans, or the [WSDOT Roadside Manual](#).

Additional guidance for maintenance of roadside vegetation can be found for some routes in the Memorandum of Understanding between the US Forest Service and WSDOT, [Highways Over National Forest Lands](#), dated July 2002. In incorporated cities, refer to guidance in Section [1600.02\(2\)](#).

### 1600.03(2)(b) Mailboxes

For mailboxes located within the Design Clear Zone, provide supports and connections as shown in the [Standard Plans](#). The height from the ground to the bottom of the mailbox may vary from 3 feet 5 inches to 3 feet 9 inches.) Coordinate with homeowners when upgrading mailboxes.

Where sidewalks are present, contact the postal service to determine the most appropriate mailbox location. Locate mailboxes on limited access highways in accordance with [Chapter 530](#), Limited Access. A turnout, as shown in [Exhibit 1600-7](#), is not needed on limited access highways with shoulders of 6 feet or more where only one mailbox is to be installed.

On managed access highways, mailboxes are to be on the right-hand side of the road in the postal carrier's direction of travel. Avoid placing mailboxes along high-speed, high-volume highways. Locate Neighborhood Delivery and Collection Box Units outside the Design Clear Zone.

#### Exhibit 1600-7 Mailbox Location and Turnout Design

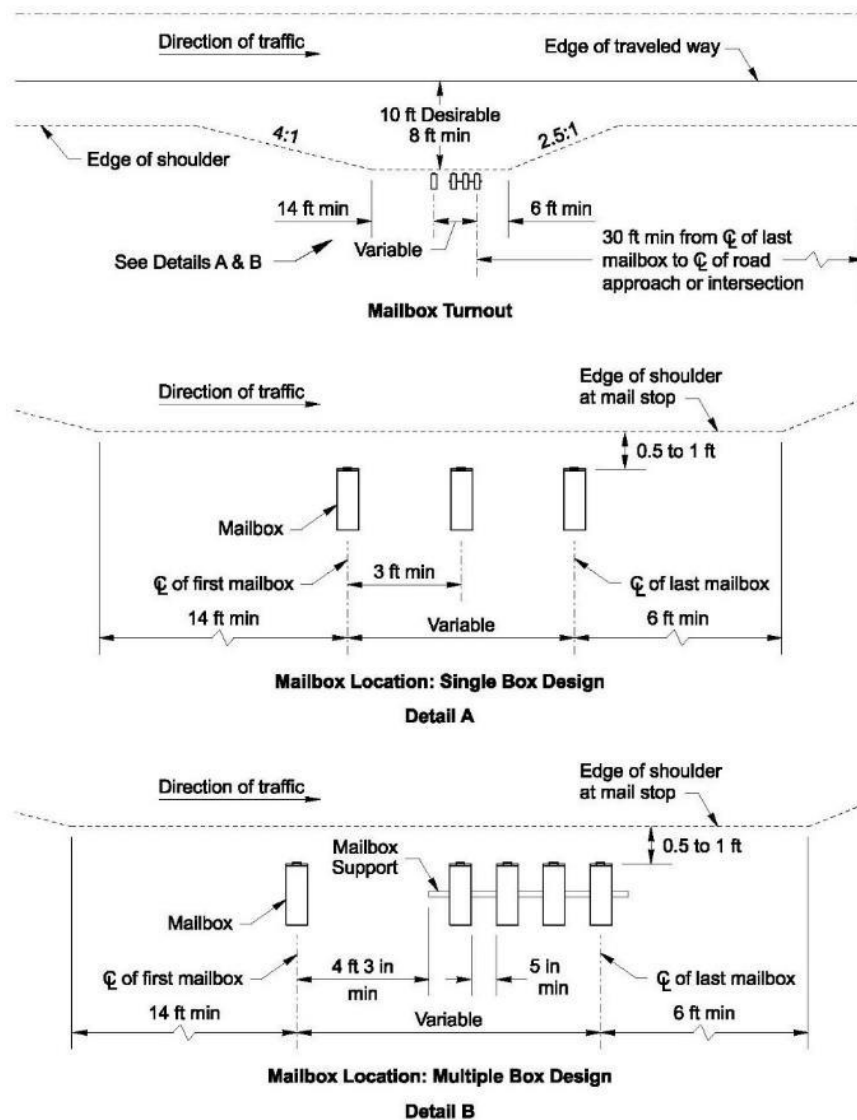

### 1600.03(2)(c) Culvert Ends

Provide a traversable end treatment when the culvert end section or opening is within the Design Clear Zone. No part of the culvert or end treatment should protrude more than 4" above the ground line. Traversable end treatments include:

- **Culverts perpendicular to direction of travel:**
  - Culverts 36" and smaller as measured parallel to the direction of travel (Consider treating these culvert ends even outside Design Clear Zone)
    - For roadway side slopes 4:1 or steeper, see Standard Plan B-70.20
    - For slopes flatter than 4:1 (see Standard Plan B-70.20 and note "treatment for slopes flatter than 4:1")
  - Culverts larger than 36 inches, as measured parallel to the direction of travel, require Type 1 safety bars. (See Standard Plan B-75.50)
- **Culverts parallel to direction of travel require safety bars:**
  - Type 2 safety bars are used for circular culverts up to 36 inches. (See Standard Plan B-75.60)
  - Type 3 safety bars are used for metal end sections of circular culverts between 36 inches and 60 inches and for metal end sections of arched culverts between 30 inches and 72 inches. (See Standard Plan B-80.20)
  - Type 4 safety bars are used for metal end sections of circular culverts between 15 inches and 60 inches and for metal end sections of arched culverts between 18 inches and 72 inches. (See Standard Plan B-80.40)

Bars are permitted where they will not significantly affect the stream hydraulics and where debris drift is minor. Consult the Region Maintenance Office and Region Hydraulics to verify these conditions. If debris drift is a concern, consult Region Hydraulics for options to reduce the amount of debris that can enter the pipe.

### 1600.03(2)(d) Signposts

Whenever possible, locate signs behind the standard run, but not the end terminals, of existing or planned traffic barrier installations to eliminate the need for breakaway posts, and place them such that the sign face is behind the barrier. (See [Chapter 1020](#) for additional information regarding the placement of signs.) Use the [MUTCD](#) to guide placement of the warning sign.

Signposts with cross-sectional areas greater than 16 square inches that are within the Design Clear Zone and not located behind a barrier are to have breakaway features as shown in the [Standard Plans](#).

Sign bridges and cantilever sign supports are designed for placement outside the Design Clear Zone or must be shielded by barrier.

### 1600.03(2)(e) Traffic Signal Standards/Posts/Supports

A design analysis is not required to install signal poles at intersections inside the Design Clear Zone because it is a common practice and practicable mitigation options for locating signal poles at these locations are limited. Although locating a signal pole outside the Design Clear Zone is desirable, this mitigation option is not feasible in many cases. Other possible mitigation options for overhead signals including breakaway supports or placing barrier to shield a signal pole are generally not feasible or desirable. Using barrier is typically not feasible due to geometric constraints and the need to accommodate pedestrians and bicyclists.

Supports for overhead ramp meter signals are generally not breakaway, but traffic barrier is an available mitigation option in most cases.

Shorter vertical signal supports are available with breakaway features. Vertical poles greater than 10-feet in height require additional grading for the breakaway features to function properly. This additional grading is the same as that required for breakaway light standards (See Section [1600.03\(2\)\(h\)](#)).

### **1600.03(2)(f) Fire Hydrants**

Fire hydrants are typically allowed on WSDOT right of way by franchise or permit. Fire hydrants that are made of cast iron can be expected to fracture on impact and can therefore be considered a breakaway device. Any portion of the hydrant that will not be breakaway must not extend more than 4 inches above the ground. In addition, the hydrant must have a stem that will shut off water flow in the event of an impact. Provide mitigation to address potential vehicle impact with hydrant types not expected to fracture on impact.

### **1600.03(2)(g) Utility Objects**

Because utilities often share the highway right of way, utility objects such as poles, guy wires, and pedestals are often located along the roadside. These features are installed in the right of way under a variety of occupancy rights; including franchises, permits, or easements. The responsibilities and liabilities associated with the presence of these objects is directly related to the documentation authorizing their installation. Importantly, the rights contained within these authorizing documents include cost responsibility for relocation. Contact the region Utility Engineer to determine if action is needed regarding utility objects located within the project limits, and the occupancy rights in effect for the objects.

For policy and guidance on locating new, and mitigating existing, utility objects along state highways, see Chapter 9 of the [Utilities Manual](#). Coordinate with the region Utilities Office to obtain guidance on utility object design or to determine mitigation requirements for existing utility objects.

### **1600.03(2)(h) Light Standards**

Provide breakaway light standards unless fixed light standards can be justified, even if outside of the Design Clear Zone. Fixed light standards may be justified if one of the following criteria are met:

- Posted speed is below 35 MPH (See Section [1600.02\(1\)](#) for Design Clear Zone in urbanized and urbanizing areas, and Section [1600.02\(2\)](#) in cities).
- Mounted on barrier (top or elbow mount).
- Behind traffic barrier, beyond the barrier's deflection design value (see [Chapter 1610](#)).
- Within a parking lot.
- Along isolated walkways and shared-use paths that are outside of Design Clear Zone.

Breakaway light standards require additional embankment widening to ensure proper operation, as shown in the [Standard Plans](#) and shall be provided in the contract plans (see WSDOT [Plans Preparation Manual](#) Section 700.08(3)). For cut sections, a culvert may be required in front-of or behind the foundation to maintain a ditch line. If this additional embankment widening cannot be constructed, such as in cases where the toe of slope will extend beyond right of way or into a water body or other sensitive area, fixed bases and traffic barrier may be considered. Document the decision to use fixed bases in the Design Documentation Package. Breakaway poles outside of the Design Clear Zone do not require additional embankment widening if the grade is constant within a 15-foot radius of the pole.

### **1600.03(2)(i) Horizontal Chain-link Fence Rails (New Section 2023)**

When an existing chain link fence with one or more horizontal rails is located within the Design Clear Zone, replace or modify the chain link fence to omit horizontal rails. When installing new chain link fencing within the Design Clear Zone, provide chain link fencing with no horizontal rails. See Standard Plan L-20.10.

### **1600.03(3) Water**

Water with a depth of 2 feet or more and located with a likelihood of encroachment by an errant vehicle is to be evaluated for mitigation.

Perform a benefit-cost analysis that considers the consequences of doing nothing versus installing a longitudinal barrier to determine the appropriate treatment (see [Chapter 321](#) for more information). For fencing considerations along water features see [Chapter 560](#).

### **1600.04 Medians**

Median barriers are normally used on limited access, multilane, high-volume highways. These highways generally have posted speeds of 45 mph or higher. Median barrier is normally placed on limited access state highways. Where median barrier is used on managed access highways where bicyclists, pedestrians, and transit users are present, consider providing accessible barrier openings at crossing locations. Install end treatments where median barrier openings are provided.

Provide median barrier on full access control multilane highways with median widths of 50 feet or less and posted speeds of 45 mph or higher. Consider median barrier on highways with wider medians or lower posted speeds when there is a history of cross-median crashes. Contact the HQ Design Office for more information. In diverging diamond interchanges that involve a single bridge structure, or in which travel directions share a continuous surface, provide a barrier in order to separate travel directions or to separate vehicles from a pedestrian facility in the median regardless of the posted speed or median width. Barrier type and design may be either project specific or selected from standard plans. Contact the HQ Design Office for more information.

Provide a left-side shoulder when installing median barrier using width criteria given in [Chapter 1230](#). Consider a wider shoulder area where the barrier might cast a shadow on the roadway and hinder the melting of ice. (See [Chapter 1239](#) for additional criteria for placement of median barrier, [Chapter 1610](#) for information on the types of barriers that can be used, and [Chapter 1260](#) for lateral clearance on the inside of a curve to provide the needed stopping sight distance.) Consider the need to accommodate drainage as a result of the addition of median barrier treatments.

When median barrier is being placed in an existing median, identify the existing crossovers and enforcement observation points. Provide the needed median crossovers in accordance with [Chapter 1370](#), considering enforcement needs. [Chapter 1410](#) provides guidance on HOV enforcement.

### **1600.05 Other Roadside Safety Features**

#### **1600.05(1) Rumble Strips and Rumble Stripes**

Rumble strips are milled grooves or rows of raised pavement markers placed perpendicular to the direction of travel, or a continuous sinusoidal pattern milled longitudinal to the direction of travel, intended to alert inattentive drivers to a potential lane departure. A sinusoidal pattern can be used when a low noise design is desired.



The pavement receiving rumble strips needs to be in good condition and thick enough to support the rumble strips. Certain pavement types, such as open graded pavements, are not suitable for rumble strip installation. Grinding rumble strips into inadequate pavement will lead to premature deterioration of the surrounding pavement. Areas where the pavement is inadequate for rumble strip installation require removal and replacement of the existing pavement at and adjacent to the location of the rumble strip. Consult with the Region Materials Engineer to determine whether the existing pavement is adequate for rumble strip installation. The Region Materials Engineer will provide a pavement design for removing and replacing the existing pavement near the rumble strip if needed. When installing both rumble strips and recessed lane markers, follow the Standard Plan to avoid overlapping the grindings.

Contact HQ Bridge to confirm if rumble strips are appropriate to be installed on bridges included in the project.

Installing rumble strips in bituminous surface treatment (or BST) or other thin surface treatments can expose pavement structure and lead to delamination. In new rumble strip locations where a BST will be applied on top of Hot Mix Asphalt (HMA) pavement, install the rumble strips in the HMA pavement before placing the BST. Increase the milling depth of the rumble strips in order to maintain the plan rumble depth by accounting for the BST thickness (see WSDOT Standard Plans). See guidance in Section [1120.02\(11\)](#) for any type of project that applies a BST (chip seal) on top of an existing rumble strip.

Provide an offset to the longitudinal paving joint so that rumble strips are not ground into the joint where practicable. For additional guidance on surface preparation and pavement stability, refer to the [WSDOT Pavement Policy](#).

The noise created when vehicle tires contact a rumble strip may adversely impact nearby residences and other land uses. Left-turning or passing vehicles, frequent passing maneuvers on two lane highways, and off-tracking of vehicles or trailers in tight radius curves, are examples of situations where incidental contact can happen. Noise impacts may be anticipated, and a low noise rumble strip design may be appropriate for use at these locations when installing rumble strips in urban growth areas, and/or within 600 feet of a residence, school, church, or campground. In situations where a low noise rumble strip is desired but is not feasible, measures can still be taken to reduce incidental contact, including discontinuing the rumble strip through frequently used road approaches, through passing zones, and in tight radius curves. Contact HQ Design for more information about low noise rumble strip designs, noise mitigation strategies, and the criteria for employing them.

There are three types of rumble strip functions: transverse, shoulder, and centerline, and each are described in the following sections.

### **1600.05(1)(a) Transverse Rumble Strips**

Transverse rumble strips are placed transversely in the traveled way to alert drivers who are approaching a change of roadway condition or object that requires substantial speed reduction or other maneuvering.

Transverse rumble strips may be placed in advance of locations such as:

- Stop-controlled intersections
- Port of entry/customs stations
- Lane reductions where crash history shows a pattern of driver inattention, and
- Horizontal alignment changes where crash history shows a pattern of driver inattention.

Transverse rumble strips may also be placed at locations where the character of the roadway changes, such as at the end of a freeway.

Contact the HQ Design Office for additional guidance on the design and placement of transverse rumble strips.

Document decisions to use transverse rumble strips in the Design Documentation Package.



### 1600.05(1)(b) Shoulder Rumble Strips and Rumble Stripes

Shoulder rumble strips (SRS) are placed parallel to the traveled way just beyond the edge line to warn drivers they are entering a part of the roadway not intended for routine traffic use. Shoulder rumble stripes are rumble strips placed immediately under the shoulder delineation paint, with any excess width milled or placed outward towards the shoulder. Shoulder rumble stripes are only installed where there is insufficient space to install shoulder rumble strips per one of the standard configurations (see Section [1600.05\(1\)\(b\)\(i\)](#) and [1600.05\(1\)\(b\)\(ii\)](#) Undivided Highways).

When shoulder rumble strips and shoulder rumble stripes are used, discontinue them where no edge stripe is present, such as at intersections and where curb and gutter are present. Discontinue shoulder rumble strips and rumble stripes where shoulder driving is allowed.

Shoulder rumble strip and rumble stripe patterns vary depending on whether bicyclists are expected to use the highway shoulder, and whether they are placed on divided or undivided highways. Rumble strip patterns for undivided highways are shallower and may be narrower than patterns used on divided highways.

Rumble strips and rumble stripes installed on undivided highways also provide gaps in the pattern, providing opportunities for bicycles to move across the pattern without having to ride across the grooves. There are four shoulder rumble strip and four shoulder rumble stripe patterns. Consult the [Standard Plans](#) (rumble strips) or [Plan Sheet Library](#) (rumble stripes) for patterns and construction details.

#### 1600.05(1)(b)(i) Divided Highways

Install shoulder rumble strips on both the right and left shoulders of rural Interstate highways. Consider them on both shoulders of rural divided highways. Use the Shoulder Rumble Strip or rumble stripe Type 1 pattern on divided highways.

Omit shoulder rumble strips or rumble stripes along highway segments where any of the following conditions occur:

- When another project scheduled within two years of the proposed project will overlay or reconstruct the shoulders or will use the shoulders for detours.
- At locations where the overall shoulder width is:
  - Less than 4-feet wide on the left (median) side of the roadway.
  - Less than 6-feet wide on the right side of the roadway (5-feet wide where rumble stripes are used).
- At locations where it's been determined that noise is an issue, and a low noise design is not appropriate (see Section [1600.05\(1\)](#)).
- As per Standard plan M-60.10.

#### 1600.05(1)(b)(ii) Undivided Highways

Shoulder rumble strips or rumble stripes are typically considered on undivided highways during centerline rumble strip installation or pavement rehabilitation. A list of prospective locations are provided to regions by HQ Design as a starting point in their development of a final list. The final list is compiled based on a field review of the prospective locations.

Omit shoulder rumble strips or rumble stripes along highway segments where any of the following conditions occur:

- Where usable shoulder for bicycles will be reduced to less than 4-feet (5-feet where barrier is present). Field-verify these dimensions.

- Where downhill grades exceed 4% for more than 500 feet in length along routes where bicyclists are frequently present.
- At locations where it's been determined that noise is an issue, and a low noise design is not appropriate (see Section [1600.05\(1\)](#)).
- As per Standard plan M-60.10.

Document decisions to omit prospective rumble strip or rumble stripe locations in the final list of locations.

When selecting a rumble strip or rumble stripe design, consult the [Standard Plans](#) and [Plan Sheet Library](#) for the patterns and construction details, and apply the following criteria:

- Consider using a low noise pattern, or employ measures to reduce incidental contact, in areas where noise impacts are anticipated (apply criteria in Section [1600.05\(1\)](#)).
- Consider using a rumble stripe in narrower sections where they can help provide the required 4-feet of usable shoulder (5-feet where guardrail is present).
- Use Shoulder Rumble Strip Type 2 or Type 3 pattern on highways with minimal bicycle traffic.
- Use the Shoulder Rumble Strip Type 4 pattern where the bicycle traffic level on the shoulder is determined to be high. Consult the region and Headquarters Bicycle and Pedestrian Coordinators to determine the bicycle traffic level and engage them in decision-making processes related to the use of rumble strips or rumble stripes on bike touring routes, and/or on other routes where bicycle events are regularly held.

### **1600.05(1)(c) Centerline Rumble Strips**

Centerline rumble strips are installed on the centerline of undivided highways to alert drivers that they are entering the opposing lane. Centerline rumble strips are installed with no differentiation between passing permitted and no passing areas. See WSDOT Standard Plan M-65.10 that shows when to continue or discontinue centerline rumble strip installation at certain roadway locations (i.e., intersections, bridges, road approaches, etc.). Refresh pavement markings when removed by centerline rumble strips. When installing both centerline rumble strips and recessed lane markers, follow Standard Plan M-65.10 to avoid overlapping the grindings.

Centerline rumble strips are typically installed on rural highways where the posted speed is 45 mph or higher. They may also be installed on urban routes with posted speeds as low as 35 mph. A list of prospective centerline rumble strip installation locations is provided to regions by HQ Design as a starting point in their development of a final list. The final list is compiled based on a detailed review of the prospective locations using the following criteria.

- Field verify lane and shoulder widths. See [Chapter 1230](#) for guidance on lane and shoulder widths. Centerline rumble strips are only installed where the combined lane and shoulder width in either direction is greater than 12 feet.
- In locations where the combined lane and shoulder width in either direction is 14 feet or less, consider the level of bicyclist and pedestrian use along the route before installing centerline rumble strips. When drivers shift their lane position away from centerline to avoid the rumble strips, they are moving closer to pedestrians and bicyclists on the shoulder.
- Consider using a low noise rumble strip design in locations where noise is an issue or employ measures for reducing incidental contact where a low noise design is not feasible (apply criteria in Section [1600.05\(1\)](#)).

- In urban areas, do not consider installing rumble strips where the need to interrupt the rumble strip pattern to accommodate left-turning vehicles is very frequent, or where the posted speed is 35 mph and below.
- Do not use centerline rumble strips where two way left-turn lanes exist.

Document the decision to omit centerline rumble strips in a Design Analysis, when that decision is outside of the policy provided in this section (see [Chapter 300](#).)

### **1600.05(2) Headlight Glare Considerations**

Headlight glare from opposing traffic is most common between opposing main line traffic. Glare screens can be used to mitigate this condition. Other conditions for which glare screen might be appropriate are:

- Between a highway and an adjacent frontage road, shared-use path, or parallel highway, especially where opposing headlights might seem to be on the wrong side of the driver.
- At an interchange where an on-ramp merges with a collector-distributor and the ramp traffic might be unable to distinguish between collector and main line traffic.
- Where headlight glare is a distraction to adjacent property owners. Playgrounds, ball fields, and parks with frequent nighttime activities might benefit from screening if headlight glare interferes with these activities.

Glare screening is normally not justifiable where the median width exceeds 20 feet, and the ADT is less than 20,000 vehicles per day. Document the decision to use glare screening using the following criteria:

- Higher frequency of night crashes compared to similar locations or based on statewide experience.
- Higher than normal ratio of night-to-day crashes.
- Unusual distribution or concentration of nighttime crashes.
- Over-representation of older drivers in night crashes.
- Combination of horizontal and vertical alignment, particularly where the roadway on the inside of a curve is higher than the roadway on the outside of the curve.
- Direct observation of glare.
- Public complaints concerning glare.

There are currently three basic types of glare screening available: chain link (see the [Standard Plans](#)), vertical blades, and concrete barrier (see [Exhibit 1600-8](#)).

When the glare is temporary (due to construction activity), consider traffic volumes, alignment, duration, presence of illumination, and type of construction activity. Glare screening may be used to reduce rubbernecking associated with construction activity, but less expensive methods, such as plywood that seals off the view of the construction area, might be more appropriate.

Exhibit 1600-8 Glare Screens

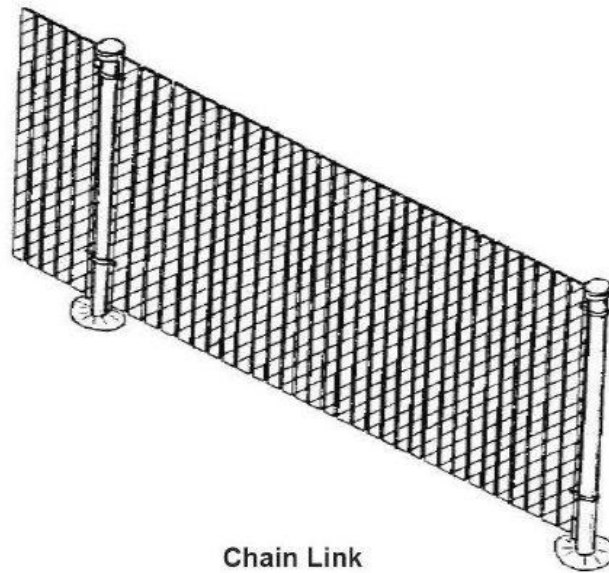

Chain Link

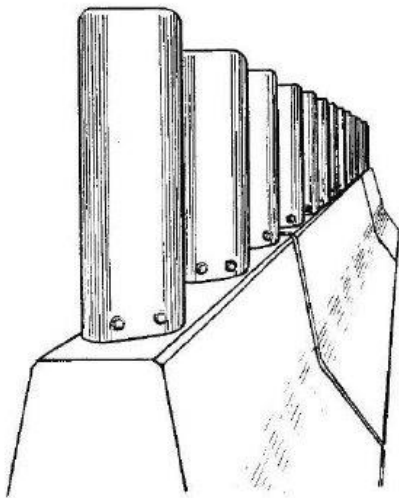

Vertical Blades

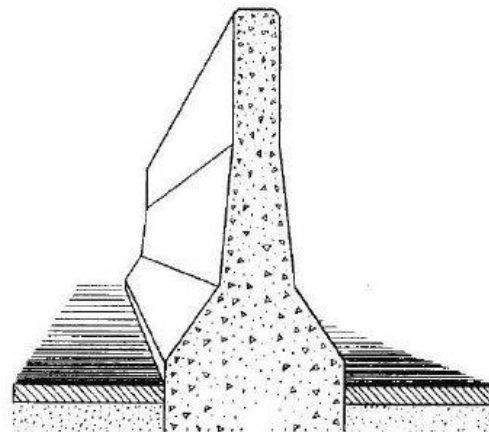

Concrete Barrier

## 1600.06 References

### 1600.06(1) Federal/State Laws and Codes

[Revised Code of Washington \(RCW\) 47.24.020\(2\)](#), Jurisdiction, control

[RCW 47.32.130](#), Dangerous objects and structures as nuisances

### 1600.06(2) Design Guidance

*Highway Safety Manual*, AASHTO

[Local Agency Guidelines](#) (City and County Design Standards), M 36-63, WSDOT

*Roadside Design Guide*, AASHTO, 2011

[Standard Plans for Road, Bridge, and Municipal Construction](#) (Standard Plans), M 21-01, WSDOT

### 1600.06(3) Supporting Information

*A Policy on Geometric Design of Highways and Streets* (Green Book), AASHTO, 2011

*Understanding Design Clear Zone* – This e-learning course for WSDOT employees covers how to determine the appropriate Design Clear Zone for recoverable and nonrecoverable slopes as well as ditches. Request this training via the web-based Learning Management System.

[Highways Over National Forest Lands](#), MOU, 2013, US Forest Service and WSDOT,  
[www.wsdot.wa.gov/publications/manuals/m22-50.htm](http://www.wsdot.wa.gov/publications/manuals/m22-50.htm)

[Utilities Manual](#), M 22-87, WSDOT. Chapter 9 provides Control Zone guidance for utilities in the WSDOT right of way.

