

DEPARTMENT OF TRANSPORTATION
INTRA-DEPARTMENTAL COMMUNICATION

DATE: October 12, 1983

FROM: D. D. Ernst *DE*
Phone: 3-6014

SUBJECT: I-205 BRIDGE MAINTENANCE AGREEMENT

To: J. L. Clemen

Attached is a fully executed agreement between the States of Washington and Oregon whereby we will split, on a 50-50 basis, the maintenance and operation costs of the I-205 bridge across the Columbia River.

DDE:ba

Attachment

cc: Duane Berentson
V. W. Korf
A. D. Andreas
E. W. Ferguson, w/attach.

| D.O.T. OCT 14 1983 Dist. 4 | |
|-------------------------------------|--------------------------------|
| <input type="checkbox"/> | District Admin. |
| <input type="checkbox"/> | Admin. Officer |
| <input type="checkbox"/> | Personnel |
| <input type="checkbox"/> | Accounting |
| <input type="checkbox"/> | Safety |
| <input type="checkbox"/> | Supply |
| <input type="checkbox"/> | Construction Engr. |
| <input type="checkbox"/> | Asst. Const. Engr. |
| <input type="checkbox"/> | Const. Assts. |
| <input type="checkbox"/> | Soils |
| <input type="checkbox"/> | Proj. Engrs. |
| <input type="checkbox"/> | Maintenance Engr. <i>rc/ka</i> |
| <input checked="" type="checkbox"/> | Asst. Maint. Engr. |
| <input checked="" type="checkbox"/> | Traffic Oper. |
| <input type="checkbox"/> | Mgmt. Analyst |
| <input type="checkbox"/> | Equip. Supt. |
| <input type="checkbox"/> | Hwy. Supts. |
| <input type="checkbox"/> | Location Engr. |
| <input type="checkbox"/> | Asst. Loc. Engr. |
| <input type="checkbox"/> | Design Engr. |
| <input type="checkbox"/> | Traffic Design |
| <input type="checkbox"/> | Plans Engr. |
| <input type="checkbox"/> | Utilities Engr. |
| <input type="checkbox"/> | Land Archt. |
| <input type="checkbox"/> | Title Engr. |
| <input type="checkbox"/> | Management Serv. |
| <input type="checkbox"/> | Prof. Control |
| <input type="checkbox"/> | Transportation |

cc Judge
cc Huber
to → File:
GC 7435

Y-TVA

AGREEMENT FOR PERPETUAL MAINTENANCE

This agreement, made and entered into by and between the State of Oregon, by and through its Department of Transportation, Highway Division, hereinafter called Oregon, and the State of Washington, acting by and through its State Transportation Commission and its Secretary of Transportation, hereinafter called Washington.

WITNESSETH

WHEREAS, Section IX of the agreement dated December 19, 1977 between Oregon and Washington for construction of the Columbia River I-205 bridge entitled "Perpetual Maintenance" called for an agreement to be prepared for sharing of maintenance costs in accordance with letters of intent dated December 13, 1971 and January 5, 1972, and;

WHEREAS, the two states have mutually agreed upon the need for maintenance and operation of the Columbia River I-205 bridge, including approaches thereto, in both states, across the Columbia River between Portland, Oregon and Vancouver, Washington to accomodate the present and anticipated volume of traffic, and;

WHEREAS, Oregon and Washington wish to establish said maintenance responsibilities and to provide for payment of costs for the operation and maintenance of said bridge.

NOW, THEREFORE, it is agreed by and between the parties hereto as follows.

I

Work included under this agreement as maintenance and repair shall consist of the upkeep and restoration of the bridge in as nearly as possible its original "as constructed" or subsequently modified condition. Also included is snow removal, sanding, sweeping, striping, repair and protection of river piers (12-26) and any other operation or activity necessary for maintenance of the structure in a usable condition.

II

Washington concurrence shall be obtained prior to making major improvements and prior to performing major rehabilitation, repairs or restoration except in an emergency.

III

Maintenance and repair of the bridge will be performed by or caused to be performed by Oregon. Upon request by Oregon during emergencies or inclement weather, Washington may, as equipment is available, assist in maintenance of the bridge.

IV

Washington shall maintain approaches in Washington at its expense. If requested by Washington during inclement weather or under emergency conditions, Oregon may, as equipment is available, assist in maintenance of Washington's approaches.

V

Oregon shall maintain approaches in Oregon at its expense. If requested by Oregon during emergencies or inclement weather Washington may, as equipment is available, assist in maintenance of Oregon's approaches.

VI

Costs incurred by Oregon and by Washington under paragraph III shall be shared equally by the states. Costs incurred under paragraph II shall be shared equally by the states unless some other division of costs is agreed upon in writing in advance of any work that is performed. Costs incurred under paragraph IV shall be Washington's responsibility and costs incurred under paragraph V shall be Oregon's responsibility.

VII

As required and in a timely manner, for purposes of advance planning and budgeting, each state will advise the other of estimated costs both for routine maintenance and for major improvements, rehabilitation, repairs or restoration. In accordance with the normal accounting procedures in each state, Oregon shall bill Washington for costs which are Washington's responsibility in accordance with this agreement and Washington shall bill Oregon for costs incurred which are Oregon's responsibility in accordance with this agreement. Each state shall promptly reimburse the other state for costs incurred under this agreement.

VIII

The responsibility for maintenance of right of way adjacent to and under the bridge and any obligations incurred in connection with the acquisition of right of way shall be the responsibility of the individual states.

IX

Definition of terms: The term "Bridge" as used in this agreement shall mean the following - a northbound and southbound structure over the north channel of the Columbia River, Washington Station 133+82 to Oregon Station 83+32 for the northbound structure and Washington

Station 134+25 to Oregon Station 82+90 of the southbound structure including roadways, super structures, abutments, bicycle ways supported by the structures and piers. "Approaches" - the roadways leading to the bridges from Oregon Station 83+32 southerly for the northbound structure and from Oregon Station 82+90 southerly for the southbound structure; from Washington Station 133+82 northerly for the northbound structure and from Washington Station 134+25 northerly for the southbound structure.

Attached hereto and marked Exhibit A is an exhibit map showing the general location of the bridge, the location of river piers 12-26, the hereinabove described ends of the north channel bridge and the approximate locations of the southerly and northerly ends of the Oregon and Washington approaches.

IN WITNESS WHEREOF, the parties hereto have set their hands and affixed their seals this 6th day of October, 1983.

The Oregon Transportation Commission, by a duly adopted delegation order, authorized its Chairman or Vice Chairman to act in its behalf in approving this agreement. Approval was given for this agreement on Sept. 26, 1983 by CHAIRMAN ANTHONY YTURRI which approval is on file in the Commission records. The delegation order also authorizes the State Highway Engineer to execute the contract on behalf of the Commission.

Approval Recommended:

Metro Region Engineer

State of Oregon, by and through its Department of Transportation, Highway Division

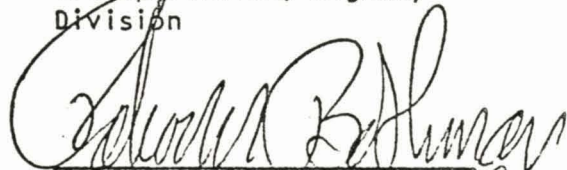

State Highway Engineer
for

APPROVED AS TO LEGAL SUFFICIENCY:

Assistant Attorney General

STATE OF WASHINGTON
Washington State
Transportation Commission

APPROVED AS TO FORM:

Assistant Attorney General
Washington

by

Secretary of Transportation

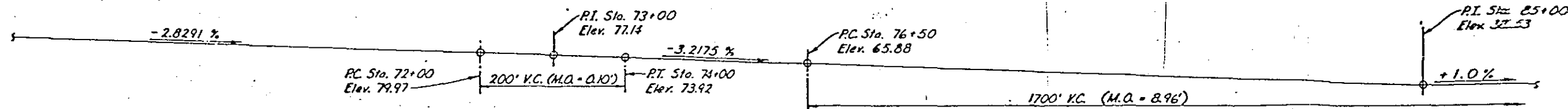

CURVE DATA

$\Delta = 0^{\circ}56'727''$
 $D = 0^{\circ}24'56.61''$
 $T = 112.499'$
 $L = 224.993'$
 $R = 13,702.125'$
 PI Sta 68+95.154
 N 707278.976
 E 1476651.999

CURVE DATA

$\Delta = 0^{\circ}39'52.27''$
 $D = 0^{\circ}34'12.94''$
 $T = 87.493'$
 $L = 174.981'$
 $R = 10,017.265'$
 PI Sta 70+95.148
 N 707092.046
 E 1476729.109

CURVE DATA

$\Delta = 1^{\circ}33'52.32''$
 $D = 0^{\circ}46'55.84''$
 $T = 100.018'$
 $L = 200.023'$
 $R = 7,325.171'$
 PI Sta 72+82.655
 N 706915.653
 E 1476792.715

CURVE DATA

$\Delta = 1^{\circ}11'53.08''$
 $D = 0^{\circ}57'31.26''$
 $T = 62.488'$
 $L = 124.971'$
 $R = 5,976.499'$
 PI Sta 74+45.163
 N 706761.321
 E 1476843.651

CURVE DATA

$\Delta mc = 58^{\circ}57'0''$
 $D = 1^{\circ}00'00''$
 $T = 3258.341'$
 $Ts2 = 4010.02'$
 $Ls2 = 500.00'$
 $S2 = 2^{\circ}30'0''$
 $O2 = 0.2$
 $Lmc = 5895.00'$
 $R = 5729.58'$
 PI Sta 107+59
 N 703,698.4
 E 1,478,110.
 PI mc Sta 107+4
 N 703605.8
 E 1477812.3

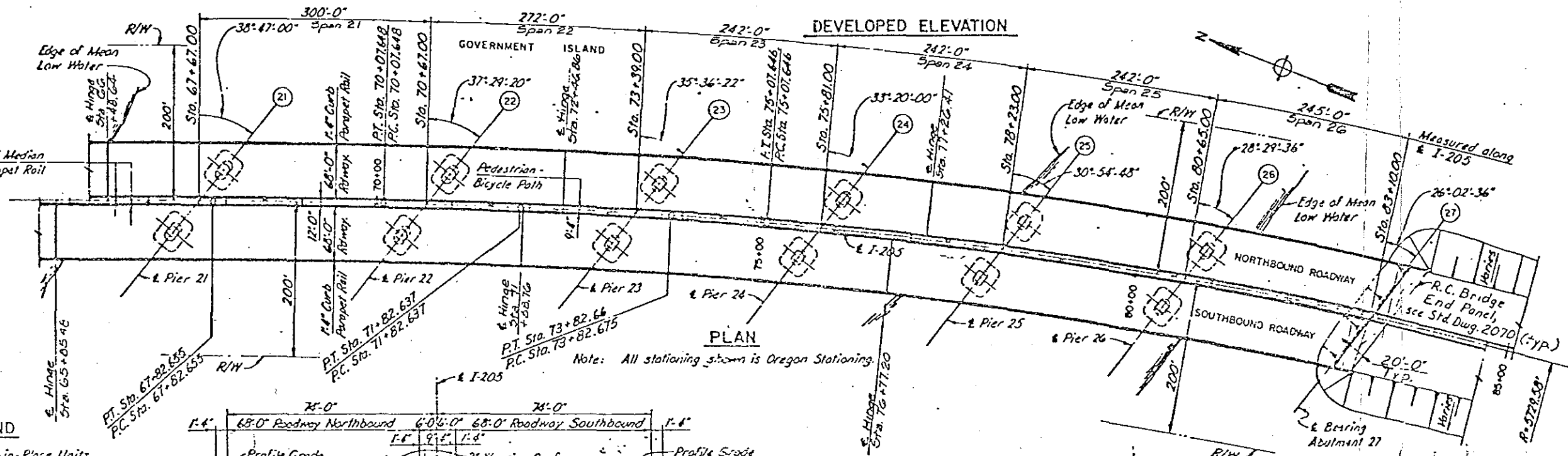
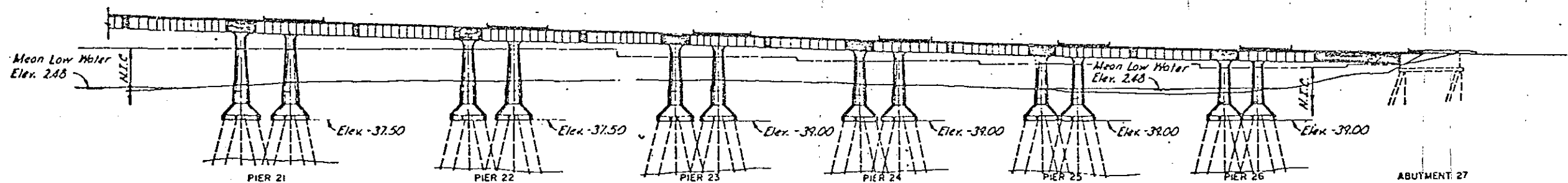

PLAN

Note: All stationing shown is Oregon Stationing.

LEGEND

- Cast-in-Place Units
- Precast Segments

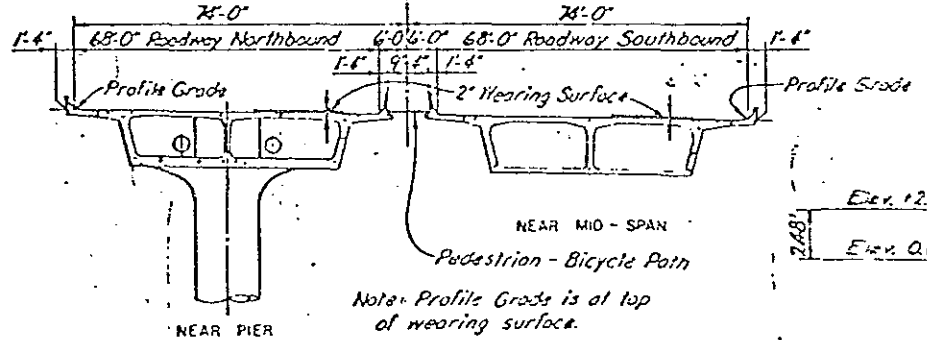

CROSS SECTION THRU SUPERSTRUCTURE

Elev. +248 = Elev. 0.00 Columbia River Datum = Mean Low Water
 Elev. 0.00 = U.S.C. & G.S. = O.S.M.D. Datum = Mean Sea Level



| PIERS 21 THRU ABUTMENT 27 | | OREGON STA | |
|---------------------------|----------|------------|------|
| DATE | REVISION | BY | DATE |
| | | | |
| | | | |
| | | | |
| | | | |
| | | | |
| | | | |
| | | | |
| | | | |
| | | | |

NOT
For General N.

EXHIBIT

CURVE DATA

$\Delta = 0^{\circ}56'727''$
 $D = 0^{\circ}24'56.61''$
 $T = 112.499'$
 $L = 224.993'$
 $R = 13,702.125'$
 P.I. Sta 68+95.154
 N 707278.976
 E 1476657.999

CURVE DATA

$\Delta = 0^{\circ}39'52.27''$
 $D = 0^{\circ}34'12.94''$
 $T = 87.493'$
 $L = 174.981'$
 $R = 10,047.265'$
 P.I. Sta 70+95.148
 N 707092.046
 E 1476729.109

CURVE DATA

$\Delta = 1^{\circ}33'52.32''$
 $D = 0^{\circ}46'55.84''$
 $T = 100.018'$
 $L = 200.023'$
 $R = 7,325.171'$
 P.I. Sta 72+82.655
 N 706915.653
 E 1476792.715

CURVE DATA

$\Delta = 1^{\circ}11'53.08''$
 $D = 0^{\circ}57'31.26''$
 $T = 62.488'$
 $L = 124.971'$
 $R = 5,976.499'$
 P.I. Sta 74+45.163
 N 706761.321
 E 1476843.651

CURVE DATA

$\Delta mc = 58^{\circ}57'01''$
 $D = 1^{\circ}00'00''$
 $T = 3258.341'$
 $Ts2 = 4010.02'$
 $Ls2 = 500.00'$
 $Sx = 2^{\circ}30'00''$
 $Ox = 0.2$
 $Lmc = 5895.00'$
 $R = 5729.58'$
 P.I. Sta 107+59.2
 N 703,698.41
 E 1,478,110.6
 P.I. mc Sta 107+45
 N 703605.84
 E 1477812.35

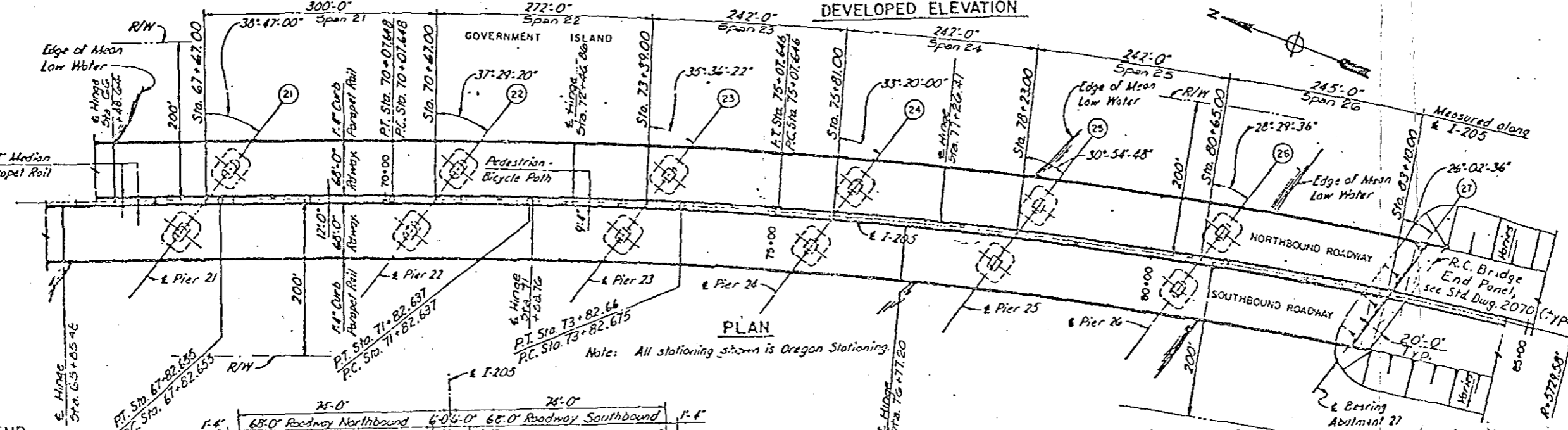
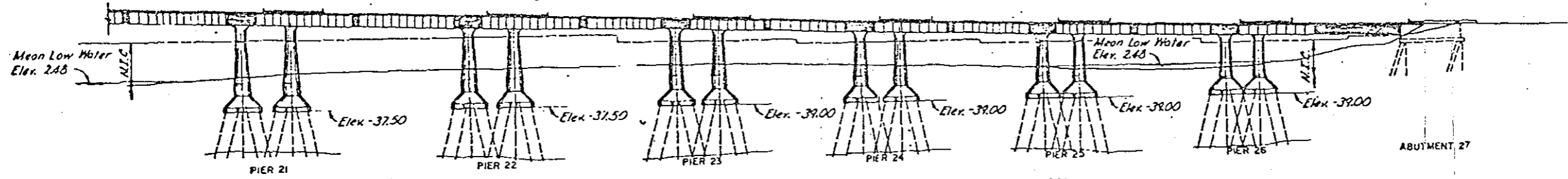
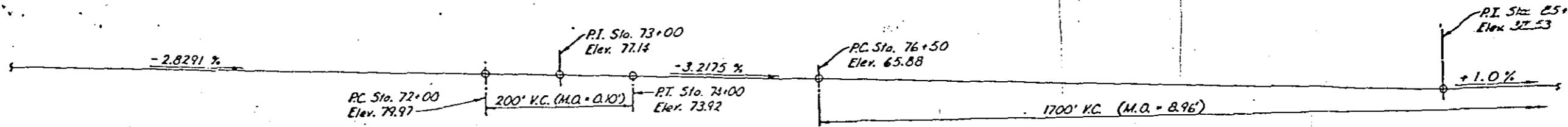

NOTE
For General No

LEGEND

- Cast-in-Place Units
- Precast Segments

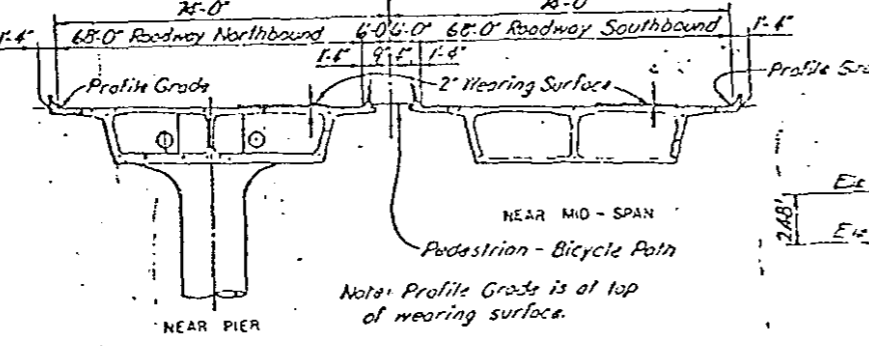

CROSS SECTION THRU SUPERSTRUCTURE

Elev. +2.48 = Elev. 0.00 Columbia River Datum = Mean Low Water
 Elev. 0.00 = U.S.C. & G.S. = O.S.M.D Datum = Mean Sea Level



| PIERS 21 THRU ABUTMENT 27 | | OREGON STAT |
|---------------------------|----------|--------------------|
| DATE | REVISION | BY |
| | | |
| APPROVED | | DATE JULY 23, 1980 |
| DESIGNED | CHECKED | SCALE |
| D.C. | D.C. | 9555 |

EXHIBIT

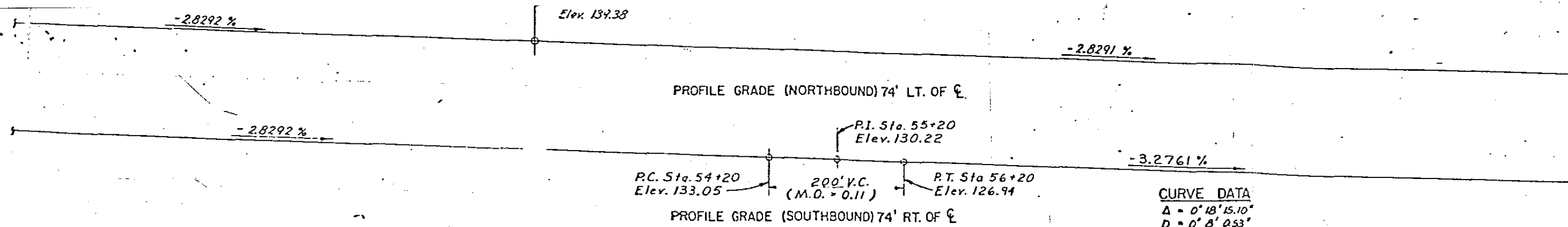

CURVE DATA

Δ = 0° 18' 15.10"
 D = 0' 8' 0.53"
 T = 13.947'
 L = 227.894'
 R = 42,924.213'
 P.I. Sta. 66 + 68.709
 N 707489.283
 E 1476574.042

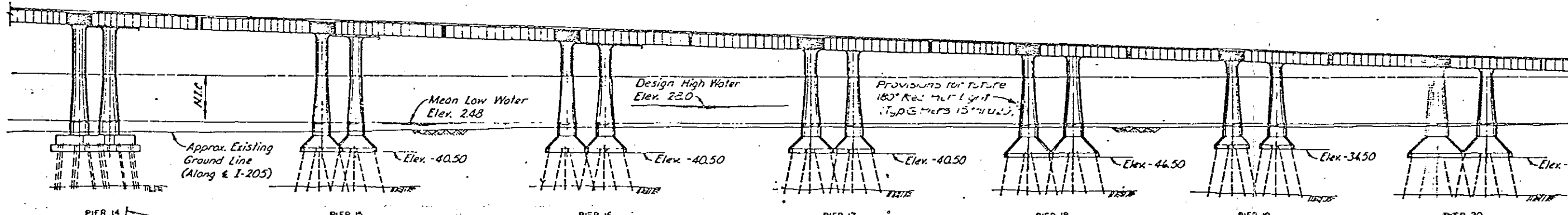

DEVELOPED ELEVATION

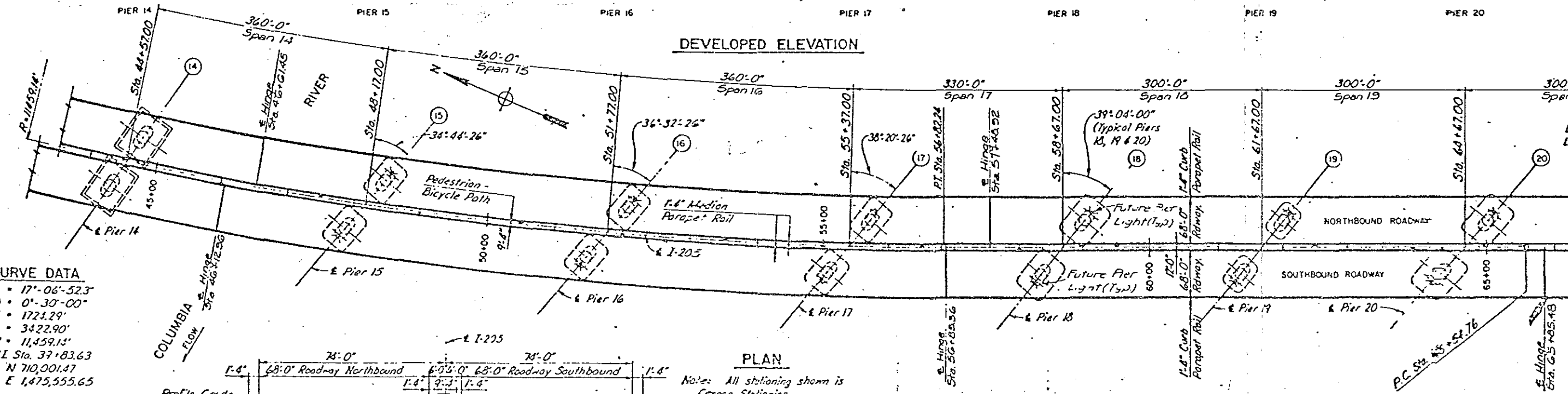

CURVE DATA

Δ = 17° 06' 52.3"
 D = 0° 30' 00"
 T = 1723.29'
 L = 3422.90'
 R = 11,459.15'
 P.I. Sta. 37 + 83.63
 N 710,001.47
 E 1,475,555.65

LEGEND

■ Cast-in-Place Units
 □ Precast Segments

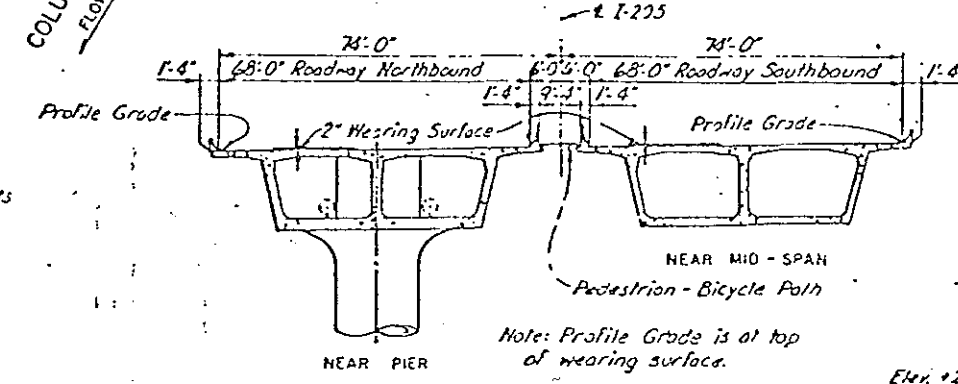

CROSS SECTION THRU SUPERSTRUCTURE

Elev. +2.48 = Elev. G.C.O. Columbia River Datum = Mean Low Water
 Elev. 0.00 = L.S.C. & G.S. = O.S.H.D. Datum = Mean Sea Level

PLAN

NOTES

For General Notes, see Draw. 1

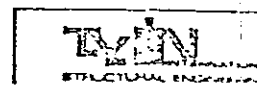

PIERS 15 THRU 20

| DATE | REVISION | OREGON STA |
|------|----------|--------------------|
| | | BP |
| | | COLUMBIA |
| | | GENERAL PLAN & E |
| | | DATE JULY 29, 1980 |

EXHIBIT

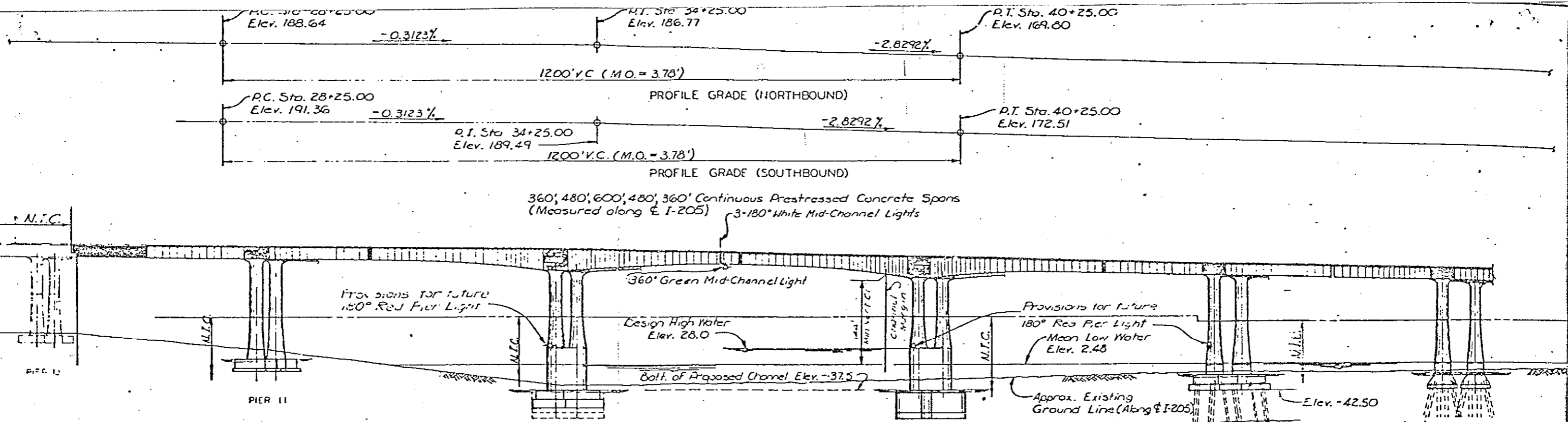

DATA
 26'-52.3'
 30'-00"
 1.29'
 2.90'
 59.14'
 39+23.63
 1001.47
 75,555.65

ELEV + 2.48 = ELEV 000 COLUMBIA RIVER DATUM = M L W
 ELEV 000 = USC & GS = OSHD DATUM = M S L

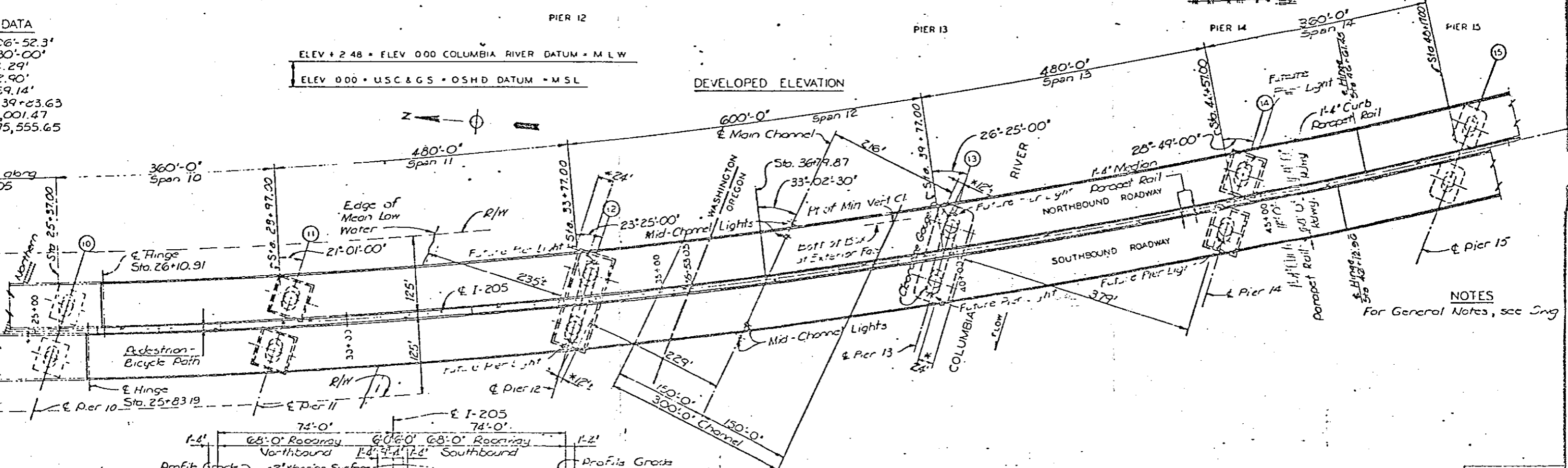

LEGEND

sa Girders & Closure Units,
 mental Cantilever Construction

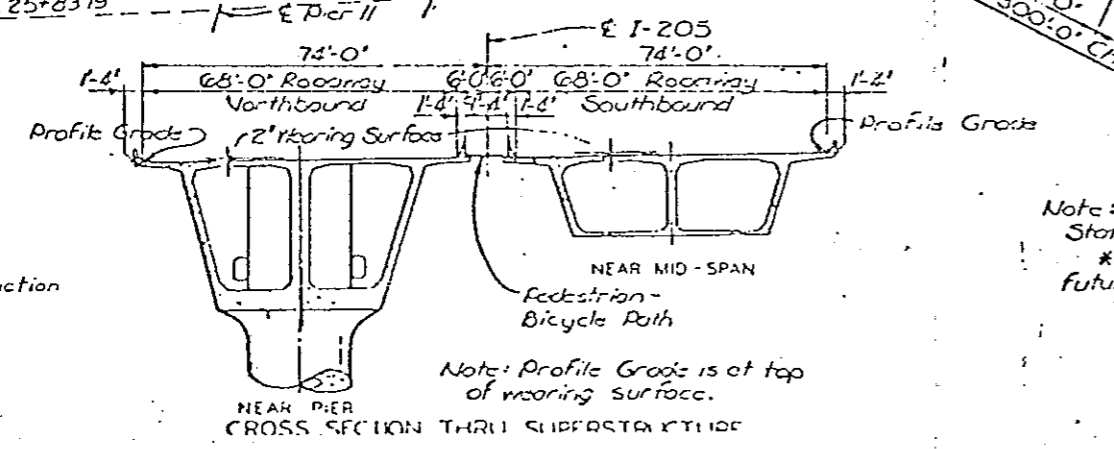

PLAN

Note: All stationing shown is Oregon Stationing.
 * Indicates provisions for possible future fence system.



| REVISED | | DATE | BY | CHECKED |
|---------|-------------|------|----|---------|
| NO. | DESCRIPTION | | | |
| | | | | |
| | | | | |
| | | | | |
| | | | | |

DATE: JULY 23, 1960

EXHIBIT A

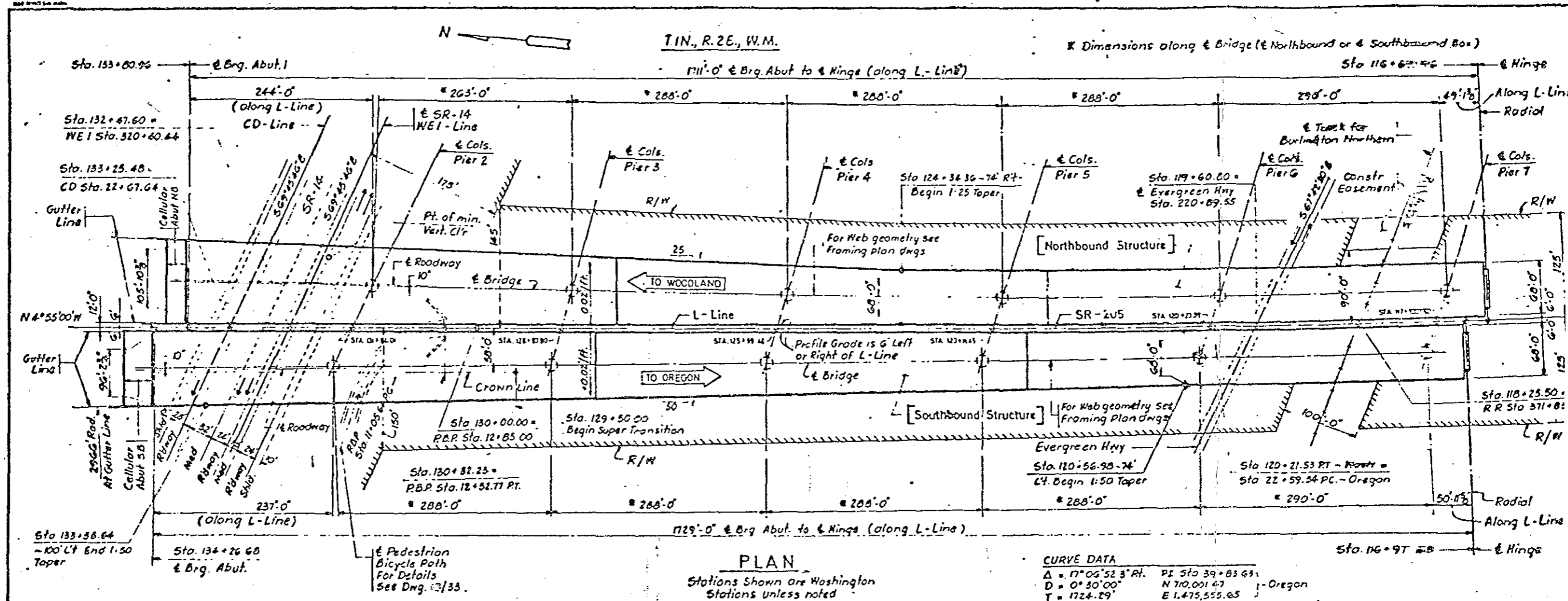

CURVE DATA

| | |
|-----------------------|-------------------------------|
| Δ = 17° 06' 52.3" Rt. | PI Sta 39+83.83 |
| D = 0° 30' 00" | N 710,001.47 |
| T = 1724.29' | E 1,475,555.65 |
| L = 3422.90' | PI Sta 103+22.92 - Washington |
| R = 11,659.14' | |

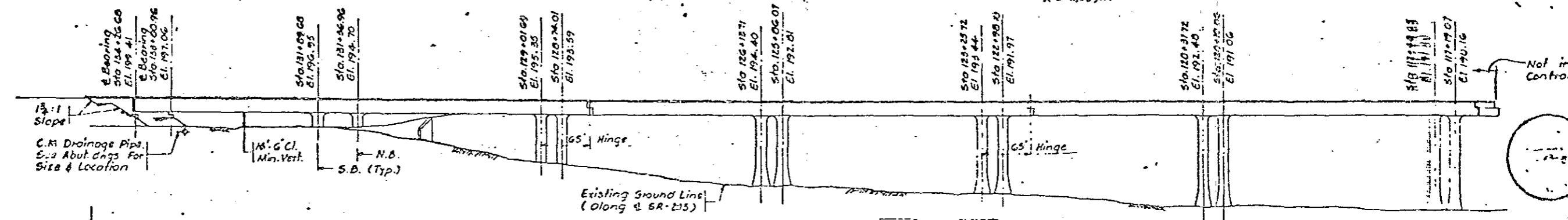

13:1 Slope
C.M. Drainage Pipe
See Abut. Dwg. For
Size & Location

1200' V.C.
+0.3125%

- Notes:**
- For Footing Location and Ground Contours See Dwg. 12/121
 - Roadway Elev's. with Super transitions, Test holes, Drains, Provision for future Electrical System and Sign Supports shown on other Sheets.

ELEVATION

Elevations shown are finished
grade Elevations at & Columns
(Not equal to Profile Grade)

NOTE
THE SCALE OF THIS PRINT IS
APPROXIMATELY 45% OF THE
ORIGINAL DRAWING.
DO NOT SCALE

- Block Notes**
- "2" specified in schedule plus 50 side P.O.S.T. L118 + 44,109 ft.
 - Top Elev. 45.35
 - T.P. 12' west 1/2" from 250 ft. north of Evergreen Highway Elev. 74.73
 - R.P. 21' to 12' apply L 122 + 80 side Elev. 102.07
 - T.P. 14' west 1/2" from Sta. 1330 + 80 Elev. 131.61
 - R.P. 21' to 25' ft. 1200 plus 52-14 WE 1 Sta. 319 + 18 Elev. 131.25
 - T.P. 112' ft. 1475 Sta. L118 + 54 Elev. 193.35

LOADING: HS-20 or TWO 24KIP AXLES @ 4' CTRS.

FOR INFORMATION ONLY

WASHINGTON STATE HIGHWAY COMMISSION
DEPARTMENT OF HIGHWAYS
OLYMPIA, WASHINGTON

DATE: DECEMBER

COLUMBIA RIVER BRIDGE, WASHINGTON APP

Dymally & Widmann Inc.

GENERAL PLAN,
ELEVATION & NOTES

| | |
|-------|-----------------|
| Scale | 1" = 60'-0" |
| Date | 1-10-78 |
| Sheet | 5 of 4 |
| Drawn | D.Y.O. No. 3216 |

GC7435

EXHIBIT A